

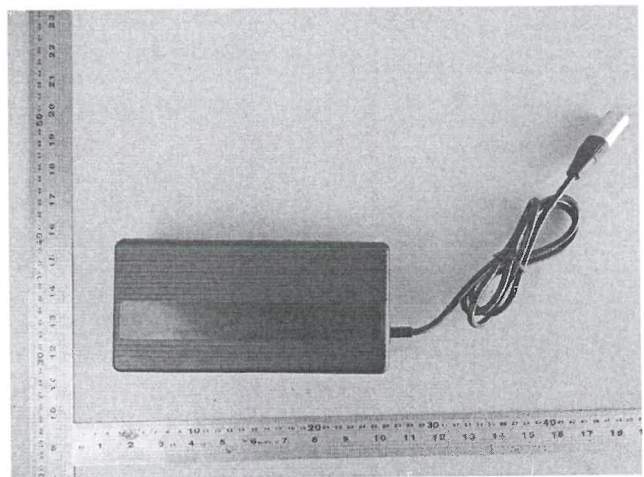

Prüfbericht-Nr.: Test Report No.:	50055233 001	Auftrags-Nr.: Order No.:	1160028606	Seite 1 von 112 Page 1 of 112
Kunden-Referenz-Nr.: Client Reference No.:	N/A	Auftragsdatum: Order date:	01.09.2016	
Auftraggeber: Client:	Wuxi Sans Electronic Co., Ltd. Industrial WuYi, DongGang Town, Wuxi, Jiangsu, P.R.China			
Prüfgegenstand: Test item:	AC/DC Power Supply			
Bezeichnung / Typ-Nr.: Identification / Type No.:	SSLC180V54.6			
Auftrags-Inhalt: Order content:	Type test			
Prüfgrundlage: Test specification:	EN 61558-2-16:2009+A1:2013 used in conjunction with EN 61558-1:2005+A1:2009			
Wareneingangsdatum: Date of receipt:	01.09.2016			
Prüfmuster-Nr.: Test sample No.:	A000460451			
Prüfzeitraum: Testing period:	01.09.2016 - 09.01.2017			
Ort der Prüfung: Place of testing:	TÜV Rheinland / CCIC (Ningbo) Co., Ltd.			
Prüflaboratorium: Testing laboratory:	TÜV Rheinland / CCIC (Ningbo) Co., Ltd.			
Prüfergebnis*: Test result*:	Pass			
geprüft von / tested by:	kontrolliert von / reviewed by:			
2017.01.12 Sophie Zhou/ PE	2017.01.12 Jianzhong Mao / TC			
Datum Date	Name / Stellung Name / Position	Unterschrift Signature	Datum Date	Name / Stellung Name / Position
				Unterschrift Signature
Sonstiges / Other:	CE LVD			
Zustand des Prüfgegenstandes bei Anlieferung: Condition of the test item at delivery:	Prüfmuster vollständig und unbeschädigt Test item complete and undamaged			
* Legende:	1 = sehr gut P(ass) = entspricht o.g. Prüfgrundlage(n)	2 = gut F(ail) = entspricht nicht o.g. Prüfgrundlage(n)	3 = befriedigend N/A = nicht anwendbar	4 = ausreichend N/T = nicht getestet
Legend:	1 = very good P(ass) = passed a.m. test specification(s)	2 = good F(ail) = failed a.m. test specification(s)	3 = satisfactory N/A = not applicable	4 = sufficient N/T = not tested
<p>Dieser Prüfbericht bezieht sich nur auf das o.g. Prüfmuster und darf ohne Genehmigung der Prüfstelle nicht auszugsweise vervielfältigt werden. Dieser Bericht berechtigt nicht zur Verwendung eines Prüfzeichens. <i>This test report only relates to the a. m. test sample. Without permission of the test center this test report is not permitted to be duplicated in extracts. This test report does not entitle to carry any test mark.</i></p>				

Test Report issued under the responsibility of:



TEST REPORT IEC 61558-2-16	
Safety of power transformers, power supplies, reactors and similar products for supply voltages up to 1100 V Part 2: Particular requirements and tests for switch mode power supply units and transformers for switch mode power supply units	
Report Number	50055233 001
Date of issue	See cover page
Total number of pages	See cover page
Name of Testing Laboratory preparing the Report	TÜV Rheinland /CCIC (Ningbo) Co., Ltd. 3F, Building C13, R&D Park, No.32 , Lane 299 Guanghua Road,National Hi-Tech Zone, Ningbo, 315048, P. R. China
Applicant's name	Wuxi Sans Electronic Co.,Ltd.
Address	Industrial WuYi, DongGang Town, Wuxi, Jiangsu, P.R.China
Test specification:	
Standard	EN 61558-2-16:2009 + A1 used in conjunction with EN 61558-1:2005 + A1
Test procedure	CE LVD
Non-standard test method	N/A
Test Report Form No	IEC61558_2_16C
Test Report Form(s) Originator	VDE Testing and Certification Institute
Master TRF	Dated 2015-06
Copyright © 2015 IEC System of Conformity Assessment Schemes for Electrotechnical Equipment and Components (IECEE System). All rights reserved.	
This publication may be reproduced in whole or in part for non-commercial purposes as long as the IECEE is acknowledged as copyright owner and source of the material. IECEE takes no responsibility for and will not assume liability for damages resulting from the reader's interpretation of the reproduced material due to its placement and context.	
If this Test Report Form is used by non-IECEE members, the IECEE/IEC logo and the reference to the CB Scheme procedure shall be removed.	
This report is not valid as a CB Test Report unless signed by an approved CB Testing Laboratory and appended to a CB Test Certificate issued by an NCB in accordance with IECEE 02.	
General disclaimer:	
The test results presented in this report relate only to the object tested. This report shall not be reproduced, except in full, without the written approval of the Issuing CB Testing Laboratory. The authenticity of this Test Report and its contents can be verified by contacting the NCB, responsible for this Test Report.	

Test item description :	AC/DC Power Supply	
Trade Mark :		
Manufacturer	Same as applicant	
Model/Type reference :	SSLC180V54.6	
Ratings :	Input: AC 100-240V, 47-63Hz, 2.5A, Class II Output: DC 54.6V, 3.0A	
Responsible Testing Laboratory (as applicable), testing procedure and testing location(s):		
<input checked="" type="checkbox"/>	Testing Laboratory:	TÜV Rheinland /CCIC (Ningbo) Co., Ltd.
	Testing location/ address :	3F, Building C13, R&D Park, No.32 , Lane 299 Guanghai Road,National Hi-Tech Zone, Ningbo, 315048, P. R. China
<input type="checkbox"/>	Associated CB Testing Laboratory:	
	Testing location/ address :	
	Tested by (name, function, signature) :	See cover page
	Approved by (name, function, signature) ... :	See cover page
Testing procedure: TMP/CTF Stage 1:		
	Testing location/ address :	
	Tested by (name, function, signature) :	
	Approved by (name, function, signature) ... :	
Testing procedure: WMT/CTF Stage 2:		
	Testing location/ address :	
	Tested by (name + signature) :	
	Witnessed by (name, function, signature) . :	
	Approved by (name, function, signature) ... :	
Testing procedure: SMT/CTF Stage 3 or 4:		
	Testing location/ address :	
	Tested by (name, function, signature) :	
	Witnessed by (name, function, signature) . :	
	Approved by (name, function, signature) ... :	
	Supervised by (name, function, signature) :	

List of Attachments (including a total number of pages in each attachment): Photo documentation (9 pages)	
Summary of testing: Pass	
Tests performed (name of test and test clause): All applicable tests were performed. Details see appended clauses and tables. The test samples are pre-production samples without serial numbers.	Testing location: TÜV Rheinland /CCIC (Ningbo) Co., Ltd. 3F, Building C13, R&D Park, No.32 , Lane 299 Guanghua Road, National Hi-Tech Zone, Ningbo, 315048, P. R. China
Summary of compliance with National Differences: EU Group Differences, EU Special National Conditions Explanation of used code: N/A <input checked="" type="checkbox"/> The product fulfils the requirements of <u>EN 61558-2-16:2009 + A1 used in conjunction with EN 61558-1:2005 + A1</u>	

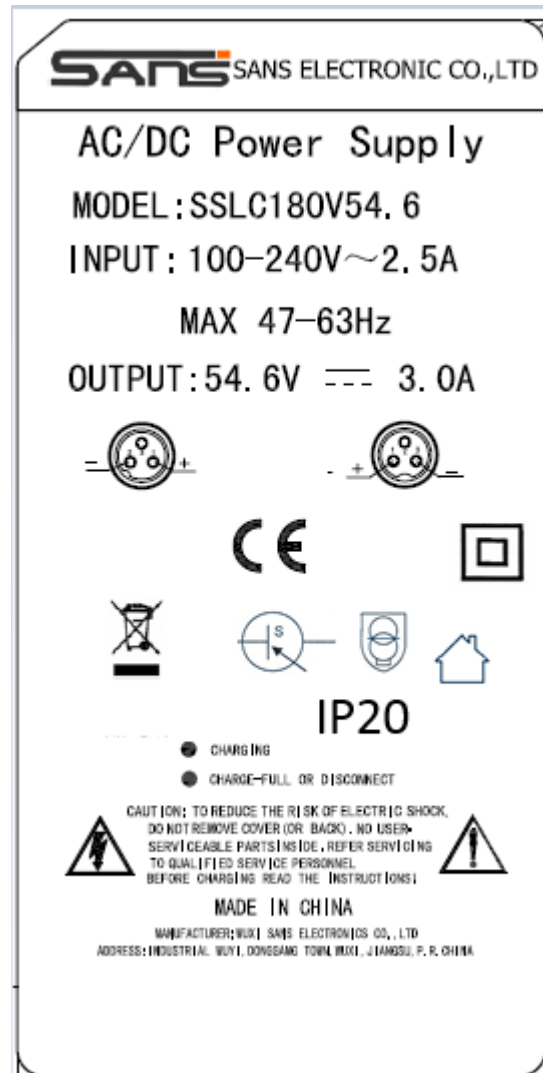

Copy of marking plate:







Note:







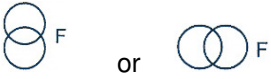

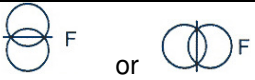
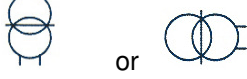



1. The artwork above may be only a draft. The use of certification marks on a product must be authorized by the respective NCBs that own these marks.
2. Manufacture or/and his importer shall ensure product bears label requirements in article 6 and article 8 of the 2014/35/EU relate to name, batch number, post address prior place the product into EU market.

Test item particulars: AC/DC Power supply	
Classification of installation and use: Portable power supply	
Supply Connection: Appliance inlet	
Possible test case verdicts:	
- test case does not apply to the test object..... : N/A	
- test object does meet the requirement..... : P (Pass)	
- test object does not meet the requirement..... : F (Fail)	
Testing :	
Date of receipt of test item : 2016-09-01	
Date (s) of performance of tests : 2016-09-01 - 2016-12-28	
General remarks:	
"(See Enclosure #)" refers to additional information appended to the report. "(See appended table)" refers to a table appended to the report.	
Throughout this report a <input type="checkbox"/> comma / <input checked="" type="checkbox"/> point is used as the decimal separator.	
Manufacturer's Declaration per sub-clause 4.2.5 of IEC60950-1:	
The application for obtaining a CB Test Certificate includes more than one factory location and a declaration from the Manufacturer stating that the sample(s) submitted for evaluation is (are) representative of the products from each factory has been provided	<input type="checkbox"/> Yes <input checked="" type="checkbox"/> Not applicable
When differences exist; they shall be identified in the General product information section.	
Name and address of factory (ies) : Wuxi Sans Electronic Co, .Ltd. Industrial WuYi, DongGang Town, Wuxi, Jiangsu, P.R.China	
General product information:	
The equipment is switching mode power supplies intended for general use in the scope of this standard. The equipment's bottom enclosure is secured to top enclosure by ultrasonic. The power supply cord was not provided together with the equipment. A suitable certified power supply cord set has to be evaluated when shipment.	

IEC 61558-2-16			
Clause	Requirement + Test	Result - Remark	Verdict
8	MARKING AND OTHER INFORMATION		P
8.1	Transformer marked with:		P
	a) rated supply voltage or voltage range (V)	100-240V ~	P
	b) rated output voltage (V)	See copy of marking plate	P
	c) rated output (VA, kVA or W)		N/A
	d) rated output current (A)	See copy of marking plate	P
	e) rated frequency (Hz)	See copy of marking plate	P
	f) rated power factor (if not 1)		N/A
	g) symbol AC for alternating current, or DC for direct current-output	See copy of marking plate	P
	h) symbol for electrical function (according to one or more part's 2) in addition with the symbol for SMPS (IEC 61558-2-16:09)	For example: 	P
	i) manufacturer's name or trademark or name of the responsible vendor	See copy of marking plate	P
	j) model or type reference	See copy of marking plate	P
	k) vector group according to IEC 60076 for three-phase transformer		N/A
	l) symbol for Class II		P
	m) symbol for Class III		N/A
	n) index IPXX if other than IP00	IP20	P
	o) rated max. ambient temperature t_a (if not 25 °C)		N/A
	p) rated minimum ambient temperature $t_{a \text{ min}}$, if <10° C and if a temperature sensitive device is used		N/A
	q) short-time duty cycle: operating time Intermittent duty cycle: operating and resting time (e.g. 5min/30min)		N/A
	r) for tw-marked transformers marked with the rated max. operating temperature, increased by multiples of 5 (e.g. tw 120; tw 125)		N/A
	s) transformers used with forced air cooling shall be marked with "AF" in m/s		N/A
	t) Information from the manufacturer to the purchaser (data sheet) :		N/A
	– short-circuit voltage (% rated supply voltage) for stationary transformers > 1000 VA		N/A
	– electrical function of the transformer		N/A

IEC 61558-2-16			
Clause	Requirement + Test	Result - Remark	Verdict
8.2	Marking for transformers IP00 or for associated transformers: type and trademark, instruction sheets		N/A
8.3	Adjusted voltage easily and clearly discernible		N/A
8.4	For each tapping or winding: rated output voltage and rated output		N/A
	necessary connections clearly indicated		N/A
8.5	For short-circuit proof transformers or non-inherently short-circuit proof transformers:		N/A
	Rated current (A or mA) and symbol for time current characteristics of the fuses for non-inherently short-circuit proof transformer with incorporated fuses and non-short-circuit proof transformer		N/A
	Manufacturer's model or type reference and rating of the device for non-inherently short-circuit proof transformers with incorporated replaceable protective device (other than fuses)		N/A
	Construction sheet for transformers with replaceable protective device (other than fuses) information with information about the replacement.		N/A
8.6	Terminals for neutral: "N"		N/A
	Terminal for protective earth marked with earthing symbol		N/A
	Identification of input terminals: "PRI"		N/A
	Identification of output terminals: "SEC"		N/A
	Symbol for any point/terminal in connection with frame or core		N/A
8.7	Indication for correct connection		P
8.8	Instruction sheet for type X, Y, Z attachments	Output cord as Z attachment.	P
8.9	Transformer for indoor use shall be marked with the relevant symbol.		P
8.10	Symbol for Class II construction not confused with maker's name or trademark.		P
	Class II transformer with parts to be mounted – delivered with all parts for class II after mounting.		N/A
	Symbol for class II transformer placed on the part which provides class II.		P
8.11	Correct symbols:		P
	Volts	V	P
	Amperes	A (mA)	P
	Volt amperes (or volt-amperes reactive for reactors)	VA or (VAR)	N/A

IEC 61558-2-16			
Clause	Requirement + Test	Result - Remark	Verdict
	Watts	W	N/A
	Hertz	Hz	P
	Input		N/A
	Output		N/A
	Direct current		P
	Neutral		N/A
	Single-phase a.c.		P
	Three-phase a.c.		N/A
	Three-phase and neutral a.c.		N/A
	Power factor		N/A
	Class II construction		P
	Class III construction		N/A
	Fuse-link		P
	Rated max. ambient temperature		N/A
	Frame or core terminal		N/A
	Protective earth		N/A
	IP number	IP20	P
	Earth (ground for functional earth)		N/A
	For indoor use only		P
	tw5 YYY		N/A
	tw10 YYY		N/A
	twx YYY		N/A
	Additional Symbols (IEC 61558-2-16:09)		P
	SMPS incorporating a Fail-safe separating transformer		N/A
	SMPS incorporating a Non-short-circuit-proof separating transformer		N/A
	SMPS incorporating a Short-circuit-proof separating transformer (inherently or non-inherently)		N/A
	SMPS incorporating a Fail-safe isolating transformer		N/A
	SMPS incorporating a Non-short-circuit-proof isolating transformer		N/A

IEC 61558-2-16			
Clause	Requirement + Test	Result - Remark	Verdict
	SMPS incorporating a Short-circuit-proof isolating transformer (inherently or non-inherently)	 or 	N/A
	SMPS incorporating a Fail-safe safety isolating transformer		N/A
	SMPS incorporating a Non-short-circuit-proof safety isolating transformer		N/A
	SMPS incorporating a Short-circuit-proof safety isolating transformer (inherently or non-inherently)		P
	SMPS incorporating a Fail-safe auto-transformer	 or 	N/A
	SMPS incorporating a Non-short-circuit proof auto-transformer	 or 	N/A
	SMPS incorporating a Short-circuit proof auto-transformer (inherently or non-inherently)	 or 	N/A
	SMPS (Switch mode power supply unit)		P
8.12	Figures, letters or other visual means for different positions of regulating devices and switches		N/A
	OFF position indicated by figure 0		N/A
	Greater output, input etc. indicated by higher figure		N/A
8.13	Marking not on screws or other easily removable parts		P
	Marking clearly discernible (transformer ready for use)		P
	Marking for terminals clearly discernible if necessary after removal of the cover		N/A
	Marking for terminals: no confusion between input and output		N/A
	Marking for interchangeable protective devices positioned adjacent to the base		N/A
	Marking for interchangeable protective devices clearly discernible after removal of cover and protective device		N/A
8.14	Special information for installation (in the catalogue, data sheet, or instruction sheet) if necessary:		P

IEC 61558-2-16			
Clause	Requirement + Test	Result - Remark	Verdict
	For non-inherently short-circuit proof transformers with non-self-resetting or non-replaceable devices (weak-point, thermal link): The device cannot be reset or replaced		N/A
	For transformers generating a protective earth conductor current of 10 mA (see also cl. 18.5.2): The installation shall be made according to the wiring rules.		N/A
	For associated- and IP00-transformers: At 10% over or under voltage in the supply voltage, the rated output of the transformer shall be selected accordingly.		N/A
	For stationary transformers exceeding 1000 VA: The short circuit voltage in % of the rated voltage		N/A
	For all transformers the electrical function: An information about the electrical function of the transformer (e.g. inherently short circuit proof safety isolating transformer)		P
	For associated- and IP00-transformers: The max. abnormal winding temperature		N/A
	For tw-transformers: The specific constant S is (e.g. S6 says S = 6000)		N/A
	For transformers with more than one output winding, not for series or parallel connection		N/A
	– an information in the instruction sheet: the transformer is not intended for series/parallel connection		N/A
	For IP00-transformers the test of 27.2 is not performed. The result may be affected by the enclosure in the final application.		N/A
8.15	Marking durable and easily legible		P

9	PROTECTION AGAINST ELECTRIC SHOCK		P
9.1	Protection against contact with hazardous live parts		P
9.1.1	A live part is not a hazardous live part if:		P
	– it is separated from the supply by double or reinforced insulation		P
	– the requirements of 9.1.1.1 or 9.1.1.2 are fulfilled		P
9.1.1.1	The touch voltage is ≤ 35 V(peak) a.c. or ≤ 60 Vd.c.	Measured maximum output voltage: 54.6Vd.c.	P

IEC 61558-2-16			
Clause	Requirement + Test	Result - Remark	Verdict
9.1.1.2	If the touch voltage is > 35 V (peak)a.c. or > 60 V d.c., the following requirements shall be fulfilled:		N/A
	The touch current shall not exceed:		N/A
	– for a.c. 0,7 mA (peak)		N/A
	– for d.c. 2,0 mA (see Annex J)		N/A
	In addition, when a capacitor is connected to live parts:		—
9.1.1.2.1	discharge: < 45 °C (between 60 V and 15 kV)		N/A
9.1.1.2.2	energy: ≤ 350 mJ (voltage >15 kV)		N/A
9.1.2	Transformers shall have an adequate protection against accessibility to hazardous live parts:		P
	The enclosure of class I and class II transformers gives an adequate protection against accidental contact with hazardous live parts.		P
	Class I transformers: accessible parts are separated from hazardous live parts by at least basic insulation.		N/A
	Class II transformers: no accessibility to basic insulation, or conductive parts separated from hazardous live parts by basic insulation.		P
	Hazardous live parts are not accessible after removal of detachable parts.		N/A
	Hazardous live parts are not accessible after removal of detachable parts except for:		N/A
	– lamps having caps larger B9 and E10		N/A
	– type D fuse holder		N/A
	Lacquers, enamel, paper, cotton, oxide film on metal parts not used for protection against accidental contact with hazardous live parts:		P
	Shafts, handles, operating levers, knobs are not hazardous live parts.		N/A
	Compliance is checked by inspection and by relevant tests according to IEC 60 529		P
	Class II transformers and Class II parts of Class I construction are tested with the test pin (fig. 3)		P
	Hazardous live parts shall not be touchable by test finger (fig. 2)		P
	for Class II transformers: metal parts separated by basic insulation from hazardous live parts not touchable by test finger		P

IEC 61558-2-16			
Clause	Requirement + Test	Result - Remark	Verdict
	hazardous live parts shall not be touchable with the test pin		P
9.1.3	Accessibility of non-hazardous live parts		P
	Non-hazardous live parts of the output circuit may be accessible if they are isolated from the input circuit by double or reinforced insulation and if the following conditions are fulfilled:		P
	– The no load output voltage is ≤ 35 V peak a.c. or ≤ 60 V ripple free d.c., both poles are accessible	Max. No load voltage 54.19Vd.c.	P
	– The no load output voltage is > 35 V peak a.c. or > 60 V ripple free d.c. and ≤ 250 V a.c., only one pole may be accessible		N/A
9.2	Transformers with primary supply plug: 1 s after the interruption of the supply the voltage between the pins do not exceed 35 V (peak) a.c. or 60 V ripple free d.c.	Measured: 8V	P
	Transformers without a primary supply plug: 5 s after the interruption of the supply the voltage between the input terminals do not exceed 35 V (peak) a.c. or 60 V ripple free d.c.		N/A
	The following tests are required :		P
	If the nominal capacitance is $\leq 0,1 \mu\text{F}$ – no test is conducted.	Total 0.80uF	N/A
	– 10 times switch the supply source on and off, or use a special equipment for to switch off at the most unfavourable electrical angle		P
	If the measured voltage is > 60 V ripple free d.c., the discharge must be $\leq 45 \mu\text{C}$.		N/A

10	CHANGE OF INPUT VOLTAGE SETTING		P
	Voltage setting not possible to change without a tool		N/A
	Different rated supply voltages:		N/A
	– indication of voltage for which the transformer is set, is discernible on the transformer.		N/A
10.101	A wide range of the input (120 V a. c. to 240 V a.c voltage is allowed (IEC 61558-2-16:09):		P
	– if the output voltages does not exceed the rated output voltage		P
	– if the no-load voltage does not exceed the limits of output voltage deviation		P

IEC 61558-2-16			
Clause	Requirement + Test	Result - Remark	Verdict

11	OUTPUT VOLTAGE AND OUTPUT CURRENT UNDER LOAD		P
11.1	Difference from rated value (without rectifier; with rectifier):		P
	a) inherently short-circuit proof transformers with one rated output voltage for output voltage: a.c. $\leq 10\%$; d.c. $\leq 15\%$		N/A
	b) inherently short-circuit proof transformers with one more than 1 rated output voltage for highest output voltage: a.c. $\leq 10\%$; d.c. $\leq 15\%$		N/A
	c) idem for other output voltages: a.c. $\leq 15\%$; d.c. $\leq 20\%$		N/A
	d) other transformers for output voltages: a.c. $\leq 5\%$; d.c. $\leq 10\%$	(see appended table)	P

12	NO-LOAD OUTPUT VOLTAGE (see supplementary requirements in Part 2)		P
	Remark: with rectifier measuring on both sides of the rectifier	The rectifier is not accessible	N/A
12.101	The no load output voltage shall not exceed (IEC 61558-2-16:09):		P
	– For SMPS incorporating separating or auto-transformers: 1000V a.c. or 1415 V ripple free d.c.		N/A
	– For SMPS including isolating transformers: 500 V a.c. or 708 V ripple-free d.c.		N/A
	– For SMPS including safety isolating transformers: 50 V a.c. or 120 V ripple-free d.c.	(see appended table)	P
	For independent transformers , this output voltage limitation applies even when output windings, not for interconnection, are connected in series		N/A
12.202	The difference between output voltage at no load and the output voltage measured in clause 11 does not exceed the values of table 101 (IEC 61558-2-16:2009), Rated output (VA) Rated value %	(see appended table)	P

13	SHORT-CIRCUIT VOLTAGE		N/A
	Difference from marking for short-circuit voltage 20%		N/A

14	HEATING		P
-----------	----------------	--	---

IEC 61558-2-16			
Clause	Requirement + Test	Result - Remark	Verdict
14.1	General requirements		P
	No excessive temperature in normal use		P
	Room temperature: rated ambient temperature $t_a \pm 5 \text{ }^\circ\text{C}$		—
	Type X, Y, Z attachments: 1 pull (5 N) to the connection windings	For output cord.	
	Upri (V): 1,1 times rated supply voltage loaded with rated impedance – for independent transformers	(see appended table)	—
	Upri (V): 1,1 times rated supply voltage: with 1 sec (A), measured with rated impedance and 1,0 times of the rated supply voltage for others than independent transformers		—
	Type X, Y, Z attachments: 1 pull (5 N) to the connection windings	For output cord.	P
	Max. temperature windings		P
	– Class A: $\leq 100 \text{ }^\circ\text{C}$		N/A
	– Class E: $\leq 115 \text{ }^\circ\text{C}$		N/A
	– Class B: $\leq 120 \text{ }^\circ\text{C}$	(see appended table 14)	P
	– Class F: $\leq 140 \text{ }^\circ\text{C}$		N/A
	– Class H: $\leq 165 \text{ }^\circ\text{C}$		N/A
	– other classes		N/A
	Temperature of external enclosures of stationary transformers:		N/A
	– metal: $\leq 70 \text{ }^\circ\text{C}$		N/A
	– other material: $\leq 80 \text{ }^\circ\text{C}$		N/A
	Temperature of external enclosure of stationary transformer $\leq 85 \text{ }^\circ\text{C}$ (not touchable with the IEC test finger)		N/A
	Temperature of external enclosures, handles, etc. of portable transformers:		P
	– continuously held parts of metal: $\leq 55 \text{ }^\circ\text{C}$		N/A
	– continuously held parts of other material: $\leq 75 \text{ }^\circ\text{C}$		N/A
	– not continuously held parts of metal: $\leq 60 \text{ }^\circ\text{C}$		N/A
	– not continuously held parts of other material: $\leq 80 \text{ }^\circ\text{C}$	(see appended table 14)	P

IEC 61558-2-16			
Clause	Requirement + Test	Result - Remark	Verdict
	Temperature of terminals for external conductors $\leq 70\text{ °C}$		N/A
	Temperature of terminals of switches $\leq 70\text{ °C}$		N/A
	Temperature of internal and external wiring:	(see appended table 14)	P
	– rubber: $\leq 65\text{ °C}$		N/A
	– PVC: $\leq 70\text{ °C}$		P
	Temperature of parts where safety can be affected:		N/A
	– rubber: $\leq 75\text{ °C}$		N/A
	– phenol-formaldehyde: $\leq 105\text{ °C}$		N/A
	– urea-formaldehyde: $\leq 85\text{ °C}$		N/A
	– impregnated paper and fabric: $\leq 85\text{ °C}$		N/A
	– impregnated wood: $\leq 85\text{ °C}$		N/A
	– PVC, polystyrene and similar thermoplastic material: $\leq 65\text{ °C}$		N/A
	– varnished cambric: $\leq 75\text{ °C}$		N/A
	Temperature rise of supports $\leq 85\text{ °C}$	(see appended table 14)	P
	Temperature of printed boards:	(see appended table 14)	P
	– bonded with phenol-formaldehyde: $\leq 105\text{ °C}$		N/A
	– melamine-formaldehyde: $\leq 105\text{ °C}$		N/A
	– phenol-furfural: $\leq 105\text{ °C}$		N/A
	– polyester: $\leq 105\text{ °C}$		N/A
	– bonded with epoxy: $\leq 140\text{ °C}$		N/A
	Electric strength between input and output windings (18.3, 1 min); test voltage (V)	4200V	P
14.101	Winding temperature measured by thermocouples at the surface of the winding(IEC 61558-2-16:09)		P
	– if the internal frequencies is $> 1\text{kHz}$		P
	– the values of Table 1 for windings temperatures are reduced by 10 °C		P
14.2	Application of 14.1 or 14.3 according to the insulation system		P
14.2.1	Class of isolating system (classified materials according to IEC 60 085 and IEC 60 216)	Class B	P

IEC 61558-2-16			
Clause	Requirement + Test	Result - Remark	Verdict
14.2.2	No classified material, or system but the measured temperature does not exceed the value of Class A		N/A
14.2.3	No classified material or system but the measured temperature exceeds the value for Class A, the live parts of the transformers are submitted to the test of 14.3		N/A
14.3	Accelerated ageing test for undeclared class of isolating system		N/A
	Cycling test (10 cycles):		N/A
	– measuring of the no-load input current (mA)		N/A
14.3.1	– heat run (temperature in table 2)		N/A
14.3.2	– vibration test: 30 min; amplitude 0,35 mm; frequency range: 10 Hz, 55 Hz, 10 Hz		N/A
14.3.3	– moisture treatment (48 h, 17.2)		N/A
14.3.4	Measurements and tests at the beginning and after each test:		N/A
	– deviation of the no-load input current, measured at the beginning of the test is 30%		N/A
	– insulation resistance acc. cl.18.1 and 18.2		N/A
	– electric strength, no breakdown (18.3); 2 min; test voltage 35% of specified value (table VI)		N/A
	– Transformers (50 or 60 Hz version) are tested after the dielectric strength test as follows: under no load; duration: 5 min; Upri(V):1,2 times rated supply voltage; frequency (Hz): 2 times rated frequency		N/A
15	SHORT-CIRCUIT AND OVERLOAD PROTECTION		P
15.1	General		P
	Tests direct after 14.1 at the same ta and without changing position.	(see appended table 15)	P
	Supply voltage between 0,9 times and 1,1 times of the rated supply voltage	(see appended table 15)	—
	Transformer with rectifier tests of 15.2 and 15.3 at the input and the output terminals of the rectifier.		N/A
	Transformers with more than one output winding or tapping, all windings tested with normal load, the winding with the highest temperature is short circuited.		N/A
	Wining protected inherently (15.2)		N/A

IEC 61558-2-16			
Clause	Requirement + Test	Result - Remark	Verdict
	– Max. temperature of winding protected inherently (insulation class): ≤ 150 °C (A); ≤ 165 °C (E); ≤ 175 °C (B); ≤ 190 °C (F); ≤ 210 °C (H)	The equipment is non-inherently short-circuit proof transformer, see 15.3.	N/A
	Winding protected by protective device:		P
	– Test according 15.3.2 - 15.3.3 – 15.3.4: max. temperature of winding during the time required or the time T given in table 4 (a) (insulation class): ≤ 200 °C (A); ≤ 215 °C (E); ≤ 225 °C (B); ≤ 240 °C (F); ≤ 260 °C (H)		N/A
	– Test according 15.3.1: max. temperature of winding during the first hour, peak value (insulation class): ≤ 200 °C (A); ≤ 215 °C (E); ≤ 225 °C (B); ≤ 240 °C (F); ≤ 260 °C (H)		N/A
	– Test according 15.3.1: max. temperature of winding after first hour, peak value (insulation class): ≤ 175 °C (A); ≤ 190 °C (E); ≤ 200 °C (B); ≤ 215 °C (F); ≤ 235 °C (H)		P
	– Test according 15.3.1: max. temperature of winding after first hour, arithmetic mean value (insulation class): ≤ 150 °C (A); ≤ 165 °C (E); ≤ 175 °C (B); ≤ 190 °C (F); ≤ 210 °C (H)		N/A
	Max. temperature of external enclosures (accessible by test finger) ≤ 105 °C	(see appended table 15)	P
	Max. temperature of insulation of wiring (rubber and PVC) ≤ 85 °C	(see appended table 15)	P
	Temperature rise of supports ≤ 105 °C	(see appended table 15)	P
15.2	For inherently short-circuit proof transformers and for transformers with rectifiers test by short circuit of the output winding at rated supply voltage x 1,1: temperature rises values in table 3		N/A
15.3	For non-inherently short-circuit proof transformers and for transformers with rectifiers: temperature rises values in table 3		P
15.3.1	Output terminals short-circuited: protection device operates, test at 0,9 ... 1,1 of the rated supply voltage	Protected by electronic circuit.	P
15.3.2	If protected by a fuse accordance with either IEC 60 269-2 or IEC 60 269-3, or a technical equivalent fuse, the transformer is loaded as in table 4.		N/A

IEC 61558-2-16			
Clause	Requirement + Test	Result - Remark	Verdict
15.3.3	If protected by a fuse accordance with either IEC 60 127 or ISO 8820, or a technical equivalent fuse, the transformer is loaded with the current as specified for the longest pre arcing time. <i>If protected by a miniature fuses in accordance to IEC 60127, 1,5 times of the rated fuse, until steady state condition (in addition)</i>		N/A
15.3.4	If protected by a circuit-breaker according to IEC 60 898 the transformer is loaded with a current equal to 1,45 times the value of the circuit-breaker rated current		N/A
15.3.5	If other overload protection than a fuse (IEC 60 127) or a circuit-breaker (IEC 60 898) test with 0,95 times of operating current	(See appended table 15)	P
	If an internal weak point is used, the test must be repeated with two new samples. The two additional samples works similar to the first sample. Temperatures in the limit of table 3		N/A
15.4	For non-short-circuit proof transformers: temperature rises values in table 3, tests as indicated in 15.3		N/A
15.5	For fail-safe transformers:		N/A
15.5.1	Three additional new specimens are used		—
	– Upri (V): 1,1 times rated supply voltage		—
	– Isec (A): 1,5 times rated output current		—
	– time until steady-state conditions t1 (h)		—
	– time until failure t2 (h): ≤ t1; ≤ 5 h		N/A
15.5.2	During the test:		N/A
	– no flames, molten material, etc.		N/A
	– temperature of enclosure ≤ 175 °C		N/A
	– temperature of plywood support ≤ 125 °C		N/A
	After the test:		N/A
	– electric strength (Cl. 18, 1 min, test voltage: 35% of specified value); no flashover or break-down for primary-to-secondary only for safety isolating, isolating and separating transformer and for primary-to-body for all kinds of transformer		N/A
	– bare hazardous live parts not accessible by test finger through holes of enclosure		N/A

IEC 61558-2-16			
Clause	Requirement + Test	Result - Remark	Verdict
15.101	Electronic circuits of the SMPS fulfil the requirements of Annex H of part 1 . After a fault: no electric shock, no fire hazard and no unintentional operation.	(Details see Annex H)	P

16	MECHANICAL STRENGTH		P
16.1	General		P
	After tests of 16.2, 16.3 and 16.4		P
	– no damage		P
	– hazardous live parts not accessible by test pin according to 9.2		P
	– no damage for insulating barriers		P
	– handles, levers, etc. have not moved on shafts	No such parts	N/A
16.2	Transformers (stationary and portable s. 16.1)	Portable	P
	For stationary and portable transformers: 3 blows, impact energy 0,5 Nm		P
16.3	Portable transformers (except of plug in transformers)		P
	For portable transformers: 100 falls, 25 mm		P
16.4	Transformers with integrated pins (plug in transformers), the following tests are carried out:		N/A
	a) plug-in transformers: tumbling barrel test: 50 x ≤ 250 g; 25 x ≤ 250 g		N/A
	b) torque test of the plug pins with 0,4 Nm		N/A
	c) pull force according to table 5 for each pin		N/A

17	PROTECTION AGAINST HARMFUL INGRESS OF WATER AND MOISTURE		P
17.1	Degree of protection (IP code marked on the transformer)	IP20	P
	Test according to 17.1.1 and for other IP ratings test according to IEC 60 529:		P
	– stable operating temperature before starting the test for < IPX8		N/A
	– transformer mounted and wired as in normal use		P
	– fixed transformer mounted as in normal use by the tests according to 17.1.1 A to L		N/A

IEC 61558-2-16			
Clause	Requirement + Test	Result - Remark	Verdict
	– portable transformers placed in the most unfavourable position and wired as in normal use		P
	– glands tightened with a torque equal to two-thirds of 25.6		N/A
	After the tests:		P
	– dielectric strength test according to 18.3		P
	Inspection:		P
	a) in dust-proof transformers no deposit of talcum powder		N/A
	b) no deposit of talcum powder inside dust-tight transformers		N/A
	c) no trace of water on live parts except SELV parts below 15 V ac or 25 V dc or insulation if hazard for the user or surroundings no reduction of creepage distances		N/A
	d) no accumulation of water in transformers IPX1 so as to impair safety		N/A
	e) no trace of water entered in any part of water-tight transformer		N/A
	f) no entry into the transformer by the relevant test probe		P
17.1.1	Tests on transformers with enclosure:		P
	A) Solid-object-proof transformers:		P
	– 2 IP2X test finger (IEC 60 529) and test pin (fig. 3)	IP20	P
	B) Solid-object-proof transformers:		N/A
	– wire 2,5 mm; force 3 N		N/A
	– IP4X, wire 1 mm; force 1 N		N/A
	C) Dust-proof transformers, IP5X; dust chamber according to IEC 60 529, fig. 2:		N/A
	a) transformer has operating temperature		N/A
	b) transformer, still operating, is placed in the dust chamber		N/A
	c) the door of the dust chamber is closed		N/A
	d) fan/blower is switched on		N/A
	e) after 1 min transformer is switched off for cooling time of 3 h		N/A
	A) Dust-tight transformers (IP6X) test according to C)		N/A

IEC 61558-2-16			
Clause	Requirement + Test	Result - Remark	Verdict
	B) Drip-proof transformers (IPX1) test according to fig. 3 of IEC 60 529 for 10 min		N/A
	C) Rain-proof transformers (IPX2) test according to fig. 3 of IEC 60 529 for 10 min in operation, any angle up to 15°		N/A
	D) Spray proofed transformers (IPX3) test according to fig. 4 of IEC 60 529 for 10 min in operation and 10 min switched off , time for complete oscillation (2 x 120°) is 4 sec.		N/A
	E) Splash-proof transformers (IPX4) test according to fig. 4 of IEC 60 529 (see F) for 10 min in operation and 10 min switched off (the tube shall oscillate 360°)		N/A
	F) Jet-proof transformer (IPX5) test according to fig. 6 of IEC 60 529 (nozzle 6,3mm)		N/A
	G) Powerful Jet-proof transformer (IPX6) test according to fig. 6 of IEC 60 529 (nozzle 12 mm)		N/A
	H) Watertight transformers (IPX7)		N/A
	I) Pressure watertight transformers (IPX8)		N/A
17.2	After moisture test (48 h for IP20, 168 h for other transformers):	48h	P
	– insulation resistance and electric strength (Cl. 18)		P

18	INSULATION RESISTANCE AND ELECTRIC STRENGTH		P
18.2	Insulation resistance between:		P
	– live parts and body for basic insulation $\geq 2 \text{ M}\Omega$		N/A
	– live parts and body for reinforced insulation $\geq 7 \text{ M}\Omega$	Between primary and enclosure: 100M Ω	P
	– input circuits and output circuits for basic insulation $\geq 2 \text{ M}\Omega$		N/A
	– input circuits and output circuits for double or reinforced insulation $\geq 5 \text{ M}\Omega$	Between input and output: 100 M Ω T2 primary to secondary: 100 M Ω core to secondary: 100 M Ω	P
	– each input circuit and all other input circuits connected together $\geq 2 \text{ M}\Omega$		N/A

IEC 61558-2-16			
Clause	Requirement + Test	Result - Remark	Verdict
	– each output circuit and all other output circuits connected together $\geq 2 \text{ M}\Omega$		N/A
	– hazardous live parts and metal parts with basic insulation (Class II transformers) $\geq 2 \text{ M}\Omega$		N/A
	– body and metal parts with basic insulation (Class II transformers) $\geq 5 \text{ M}\Omega$		N/A
	– metal foil in contact with inner and outer surfaces of enclosures $\geq 2 \text{ M}\Omega$		N/A
18.3	Electric strength test (1 min): no flashover or breakdown:		P
	1) basic insulation between input circuits and output circuits; working voltage (V); test voltage (V)		N/A
	2) double or reinforced insulation between input circuits and output circuits; working voltage (V); test voltage (V)	Between input and output: 4200V T2 primary to secondary: 4200V	P
	3) basic or supplementary insulation between:		P
	a) live parts of different polarity; working voltage (V); test voltage (V)	Between L/N after fuse open-circuit: 2100V	P
	b) live parts and the body if intended to be connected to protective earth		N/A
	c) inlet bushings and cord guards and anchorages		N/A
	d) live parts and an intermediate conductive part		N/A
	e) intermediate conductive parts and body		N/A
	4) Reinforced insulation between the body and live parts; working voltage (V); test voltage (V) :	Between primary and enclosure 4200V	P
	5) Functional insulation for windings intended to be connected in series or parallel (test voltage = working voltage + 500 V) (IEC 61558-2-16:09)		N/A
18.4	Does not apply (IEC 61558-2-16:09)		-
18.101	Impulse test according Table F5 of IEC 60664-1 with 1,2/50 μs (IEC 61558-2-16)	4923V _{peak} applied	P
	– After the test of 18.3, 10 impulses of each polarity between input and output terminals		P
	– During the tests no breakdown of the insulation between turns of a winding, between input and output circuits, or between windings and any conductive core		P

IEC 61558-2-16			
Clause	Requirement + Test	Result - Remark	Verdict
18.102 (A1)	Partial discharge tests according to IEC 60664-1, if the working voltage is > 750 V peak		N/A
	Partial discharge is ≤ 10 pC at time P2 See Fig. 19.101		N/A
18.5	Touch current and protective earth current		P
18.5.1	Touch current		P
	Touch current measured after the clause 14 test (hot) for class I and class II transformers (class II transformers with metal foil at the plastic surface). The test circuit according figure 8. Measuring network according Figure J1 (Annex J). If the frequency is >30kHz, measuring across the 500 Ohm resistor of J1 (burn effects).		P
	Measurement of the touch current with switch p of picture 8 in both positions and in combination with switches e and n. The measured values are less than the required values of table 8b.		P
	– switches n and e in on position	0.148mA max. between output to L/N 0.088mA max. between enclosure to L/N	P
	– switch n: off and switch e: on	0.148mA max. between output to L/N 0.088mA max. between enclosure to L/N	P
	– switch n: on and switch e: off	0.148mA max. between output to L/N 0.088mA max. between enclosure to L/N	P
18.5.2	Protective earth conductor current		N/A
	The transformer is connected as in clause 14 Impedance of the ammeter < 0,5 Ohm, connected between earth terminal of the transformer and protective earth conductor		N/A
	The measured values are less than the required values of table 8b.		N/A
19	CONSTRUCTION		P
19.1	Separation of input and output circuits		P
19.1.1	SMPS incorporating auto-transformers (IEC 61558-2-16:2009)		N/A

IEC 61558-2-16			
Clause	Requirement + Test	Result - Remark	Verdict
19.1.1.1	For plug connected auto-transformers with rated input voltage > rated output voltage the potential to earth shall not exceed the rated output voltage. (IEC 61558-2-16:2009)		N/A
19.1.1.2	SMPS with polarised input and output plug and socket-outlet system: an instruction is given with the information, that the transformer shall not be used with non-polarised plug and socket outlet system. (IEC 61558-2-16:2009)		N/A
19.1.1.3	A polarity detecting device only energises the output in the case: output potential to earth \leq rated output voltage, also with reversed input plug. (IEC 61558-2-16:2009)		N/A
	– The contact separation of the device is \geq 3mm		N/A
	– A current to earth does not exceed 0,75 mA.		N/A
	– All tests are repeated under fault conditions of H.2.3 of annex H of part 1. The potential to earth does not exceed the max output voltage for more than 5 s.		N/A
19.1.2	SMPS incorporating separating transformers (IEC 61558-2-16:09)		N/A
19.1.2.1	Input and output circuits electrically separated. (IEC 61558-2-16:09)		N/A
19.1.2.2	The insulation between input and output winding(s) consist of basic insulation (IEC 61558-2-16:09)		N/A
	Class I SMPS		N/A
	– Insulation between input windings and body consist of basic insulation		N/A
	– Insulation between output windings and body consist of basic insulation		N/A
	Class II SMPS (IEC 61558-2-16:2009)		N/A
	– Insulation between input windings and body consist of double or reinforced insulation		N/A
	– Insulation between output windings and body consist of double or reinforced insulation		N/A
19.1.2.3	The insulation between input windings and intermediate conductive parts and the output windings and intermediate part consist of basic insulation (IEC 61558-2-16:09)		N/A
	For class I SMPS the insulation between input and output windings via the intermediate conductive parts consist of basic insulation (IEC 61558-2-16:2009)		N/A

IEC 61558-2-16			
Clause	Requirement + Test	Result - Remark	Verdict
	For class II SMPS the insulation between input winding and the body and between the output windings and the body via the intermediate conductive parts consist of double or reinforced insulation. (IEC 61558-2-16:2009)		N/A
19.1.2.4	Parts of output circuits may be connected to protective earth (IEC 61558-2-16:09)		N/A
19.1.2.5	No direct contact between output circuits and the body, unless: (IEC 61558-2-16:2009)		N/A
	– Allowed for associated transformers by the equipment standard		N/A
	– Clause 19.8 of part 1 is fulfilled		N/A
19.1.3	SMPS incorporating isolating transformers and safety isolating transformers (IEC 61558-2-16:09)		P
19.1.3.1	Input and output circuits electrically separated (IEC 61558-2-16:09)		P
	No possibility of any connection between these circuits		P
19.1.3.2	The insulation between input and output winding(s) consist of double or reinforced insulation (exception see 19.1.3.4) (IEC 61558-2-16:09)		P
	Class I SMPS not intended for connection to the mains by a plug:		—
	– Insulation between input windings and body connected to earth consist of basic insulation rated to the input voltage		N/A
	– Insulation between output windings and body, connected to earth consist of basic insulation rated for the output voltage		N/A
	Class I SMPS intended for connection to the mains by a plug (EN 61558-2-16:09):		N/A
	– Insulation between input windings and body connected to earth consist of basic insulation rated to the working voltage		N/A
	– Insulation between output windings and body, connected to earth consist of supplementary insulation rated for the working voltage		N/A
	Class II SMPS (IEC 61558-2-16:2009)		P
	– Insulation between input windings and body consist of double or reinforced insulation rated to the input voltage		P

IEC 61558-2-16			
Clause	Requirement + Test	Result - Remark	Verdict
	– Insulation between output windings and body consist of double or reinforced insulation, rated to the output voltage		P
19.1.3.3	SMPS with intermediate conductive parts not connected to the body (between input/output) (EN 61558-2-16:09):		N/A
19.1.3.3.1	For class I and class II SMPS the insulation between input and output windings, via intermediate conductive parts, consist of double or reinforced insulation, rated to the working voltage (EN 61558-2-16:09).		P
	– For class II SMPS the insulation between input winding and the body and between the output windings and the body via the intermediate conductive parts consist of double or reinforced insulation. (rated to the input voltage, for SELV circuits only basic insulation to the body)		N/A
	– For transformers, different from independent, the insulation between input and output windings, via intermediate conductive parts, consist of double or reinforced insulation, rated to the working voltage.		P
19.1.3.3.2	Class I transformers with earthed core, and not allowed for class II equipment (EN 61558-2-16:09)		N/A
	– Insulation from the input to the earthed core: basic insulation rated for the input voltage		N/A
	– Insulation from the output voltage to the earthed core: basic insulation rated for the output voltage		N/A
19.1.3.3.3	Insulation between : input to intermediate conductive parts and output and intermediate parts consist of at least basic insulation (EN 61558-2-16:09)		P
	– If the insulation from input or output to the intermediate metal part is less than basic insulation, the part is considered to be connected to input or output.		N/A
19.1.3.4	For class I SMPS, with protective screen, not connected to the mains by a plug the following conditions comply (EN 61558-2-16:09):	Class II SMPS	N/A
	– The insulation between input winding and protective screen consist of basic insulation (rated input voltage)		N/A

IEC 61558-2-16			
Clause	Requirement + Test	Result - Remark	Verdict
	– The insulation between output winding and protective screen consist of basic insulation (rated output voltage)		N/A
	– The protective screen consist of metal foil or a wire wound screen extending the full width of the windings and has no gaps or holes		N/A
	– Where the protective screen does not cover the entire width of the input winding, additional insulation to ensure double insulation in this area, is used.		N/A
	– If the screen is made by a foil, the turns are isolated, overlap at least 3 mm		N/A
	– The cross-section of the screen and the lead out wire is at least corresponding to the rated current of the overload device		N/A
	– The lead out wire is soldered or fixed to the protective screen.		N/A
	Protective screening is not allowed for SMPS with plug connection to the mains (EN 61558-2-16:09)		N/A
19.1.3.5	No connection between output circuit and protective earth, except of associated transformers (allowed by equipment standard) or 19.8 is fulfilled (EN 61558-2-16:09).		N/A
19.1.3.6	No connection between output circuit and body, except of associated transformers (allowed by equipment standard) (EN 61558-2-16:09)		P
19.1.3.7	The distance between input and output terminals for the connection of external wiring is 25 mm		N/A
19.1.3.8	Portable SMPS having an rated output ≤ 630 VA (EN 61558-2-16:09)		P
19.1.3.9	No connection between output circuit and body except of associated transformers (allowed by equipment standard) (EN 61558-2-16:09)		P
19.1.3.10	Protective screening is not allowed for SMPS with plug connection to the mains (EN 61558-2-16:09)		N/A
19.2	Fiercely burning material not used		P
	Unimpregnated cotton, silk, paper and fibrous material not used as insulation		P
	Wax-impregnated, etc. not used		P
19.3	Portable transformer: short-circuit proof or fail-safe		P
19.4	Class II transformers: contact between accessible metal parts and conduits or metal sheaths of supply wiring impossible		N/A

IEC 61558-2-16			
Clause	Requirement + Test	Result - Remark	Verdict
19.5	Class II transformers: part of supplementary or reinforced insulation, during reassembly after routine servicing not omitted		P
19.6	Class I and II transformers: creepage distances and clearances over supplementary or reinforced insulation if wire, screw, nut, etc. become loose or fall out of position not 50% specified values (Cl. 26)		P
19.7	Conductive parts connected to accessible metal parts by resistors or capacitors shall be separated from hazardous live parts by double or reinforced insulation	See 19.8.	P
19.8	Resistors or capacitors connected between hazardous live parts and the body (accessible metal parts) consist of:		P
	– components according to IEC 60 065, 14.1 or capacitor Y1 according to IEC 60 384-14	Approved Y capacitors used.	P
	– at least two separate components	CY6&CY7 bridged in series.	P
	– if one component is short-circuited or opened, values specified in Cl. 9 shall not be exceeded		P
	– if the working voltage is ≤ 250 V, one Y1 capacitor according 60384-14 is allowed		P
19.9	Insulation material input/output and supplementary insulation of rubber resistant to ageing	No such material	N/A
	Creepage distances (if cracks) specified values (Cl. 26)		N/A
19.10	Protection against accidental contact by insulating coating:	No such material	N/A
	a) ageing test (section I, IEC 60 068-2-2), test Ba: 168 h; 70 °C		N/A
	b) impact test (spring-operated impact hammer according to IEC 60 068-2-63; 0,5 ± 0,05 J)		N/A
	c) scratch test (hardened steel pin) electric strength test according to Cl. 18		N/A
19.11	Handles, levers, knobs, etc.:	No such parts	N/A
	– insulating material		N/A
	– supplementary insulation covering		N/A
	– separated from shafts or fixing by supplementary insulation		N/A
19.12	Windings construction		P
19.12.1	Undue displacement in all types of transformers not allowed:		P

IEC 61558-2-16			
Clause	Requirement + Test	Result - Remark	Verdict
	– of input or output windings or turns thereof	Fixed by bobbin and insulation tape	P
	– of internal wiring or wires for external connection	Fixed by bobbin and insulation tape	P
	– of parts of windings or of internal wiring in case of rupture or loosening	Fixed by bobbin and insulation tape	P
19.12.2	Serrated tape:		N/A
	– distance through insulation according to table 13		N/A
	– one additional layer of serrated tape, and		N/A
	– one additional layer without serration		N/A
	– in case of cheekless bobbins the end turns of each layer shall be prevented from being displaced		N/A
19.12.3 (A1)	Insulated windings wires providing basic, supplementary or reinforced insulation, meet the following requirements:		P
	– Multi-layer extruded or spirally wrapped insulation, passed the tests of annex K		P
	– Basic insulation: two wrapped or one extruded wire		N/A
	– Supplementary insulation: two layers, wrapped or extruded		N/A
	– Reinforced insulation: three layers wrapped or extruded	Approved triple insulated wire used	P
	Spirally wrapped insulation:		N/A
	– creepage distances between wrapped layers > cl. 26 _ P1 values		N/A
	– path between wrapped layers sealed, the test voltage of K2 is multiplied with 1,35		N/A
	– test 26.2.3 – Test A, passed for wrapped layers		N/A
	– the finished component pass the electric strength test according to cl. 18.3		N/A
a)	Insulated winding wire used for basic or supplementary insulation in a wound part:		N/A
	– comply with annex K		N/A
	– two layers for supplementary insulation		N/A

IEC 61558-2-16			
Clause	Requirement + Test	Result - Remark	Verdict
	– one layer for basic insulation		N/A
	– one layer for mechanical separation between the insulated wires of primary and secondary. This layer fulfils the requirement of basic insulation.		N/A
b)	Insulated winding wire used for reinforced insulation in a wound part:	Approved triple insulated wire used	P
	– comply with annex K		P
	– three layers		P
	– relevant dielectric strength test of 18.3		P
	Where the insulated winding wire is wound:		P
	– upon metal or ferrite cores		N/A
	– upon enamelled wire	Additional 2 layers tape between windings	P
	– under enamelled wire		P
	– one layer for mechanical separation between the insulated wires and the core or the enamelled wires is required. This layer fulfils the requirement of basic insulation.		P
	– both windings shall not touch each other and also not the core.	Additional insulation tube used	P
	100 % routine test of Annex K3 of part 1 is fulfilled		P
	no creepage distances and clearances for insulated winding wirers		-
	for TIW wires values of box 2) c) of table 13, table C.1 and table D.1 of part 1 and of clause 26.106 are not required		-
FIW	<u>Transformers which use FIW wire</u>	No FIW used.	N/A
19.12.101 (A1)	Max. class F for transformers which use FIW-wire		N/A
19.12.102 (A1)	FIW wires comply with IEC 60851-5, Ed.4.1; IEC 60317-0-7 and IEC 60317-56, Ed.1.		N/A
	– other nominal diameter as mentioned in table 19.101 can be calculated with the formula after table 19.111		N/A
	FIW wire used for basic or supplementary insulation for transformers according 19.1.2 (separating-transformers) of IEC 61558-2-16:		N/A

IEC 61558-2-16			
Clause	Requirement + Test	Result - Remark	Verdict
	– the test voltage of table 8a – part 1, based on the working voltage of basic or supplementary insulation, comply with the min. voltage strength of table 19.111		N/A
	– one layer for mechanical separation is located between the insulated wires of primary and secondary. This layer fulfil the requirement of basic insulation		N/A
	– between FIW and enamelled wire, no requirements of creepage distances and clearances		N/A
	– no touch of FIW and enamelled wires (grad 1, or grad 2 ...)		N/A
	FIW wire used for double or reinforced insulation for transformers according 19.1.3 (isolating and safety isolating transformers) of IEC 61558-2-16 (PRI and SEC basic insulated FIW-wire):		N/A
	– the test voltage of table 8a – part 1, based on the working voltage of basic or supplementary insulation, comply with the min. voltage strength of table 19.111		N/A
	– for primary and secondary winding FIW-wire for basic insulation is used		N/A
	– one layer for mechanical separation is located between the insulated wires of primary and secondary. This layer fulfil the requirement of basic insulation		N/A
	– no touch between the basic insulated PRI and SEC FIW-wires		N/A
	– between PRI- and SEC-FIW wires, no requirements of creepage distances and clearances		N/A
	Alternative construction used for reinforced insulation (reinforced insulated FIW wire and enamelled wire)		N/A
	– the test voltage of table 8a – part 1, based on the working voltage reinforced insulation, comply with the min. voltage strength of table 19.111		N/A
	– one layer for mechanical separation is located between the reinforced insulated FIW wire and the enamelled wire. This layer fulfil the requirement of basic insulation		N/A

IEC 61558-2-16			
Clause	Requirement + Test	Result - Remark	Verdict
	– no touch between the FIW wire and the enamelled wire		N/A
	– between the reinforced FIW wire and any other parts, no requirements of creepage distances and clearances exist		N/A
	Alternative construction with FIW wires, basic or supplementary insulated for transformers with double or reinforced insulation according to 19.1.3 (basic/supplementary insulated FIW wire + enamelled wire + creepage distance and clearances for basic insulation)		N/A
	– the test voltage of table 8a – part 1, based on the working voltage of basic or supplementary insulation, comply with the min. voltage strength of table 19.111		N/A
	– PRI or SEC basic insulated FIW wire and to the other winding (enamelled wire) requirements of supplementary insulation		N/A
	– creepage distances and clearances between the basic insulated FIW wire and the enamelled wire for basic or supplementary insulation are required.		N/A
	Where the FIW wire is wound		N/A
	– upon metal or ferrite cores		N/A
	– one layer for mechanical separation between the insulated wires and the core or the enamelled wires is required. This layer fulfils the requirement of basic insulation.		N/A
	– both windings shall not touch each other and also not the core.		N/A
19.13	Handles, operating levers and the like shall be fixed		N/A
19.14	Protection against electric shock: covers securely fixed, 2 independent fixing means, one with tool		P
19.15	Transformer with pins for fixed socket-outlets: no strain on socket-outlet		N/A
	Additional torque $\leq 0,25$ Nm		N/A
19.16	Protection index for portable transformers:		P
	≤ 200 VA \geq IP20 and instructions for use	<200VA, IP20, for indoor use only.	P
	> 200 VA $\leq 2,5$ kVA \geq IPX4 (single-phase)		N/A
	> 200 VA $\leq 6,3$ kVA \geq IPX4 (polyphase)		N/A

IEC 61558-2-16			
Clause	Requirement + Test	Result - Remark	Verdict
	> 2,5 VA (single-phase) ≥ IP21		N/A
	> 6,3 VA (polyphase) ≥ IP21		N/A
19.17	Transformers IPX1 - IPX6 totally enclosed, except for drain hole (diameter ≥ 5 mm or 20 mm ² with width ≥ 3 mm); drain hole not required for transformer completely filled with insulating materials		N/A
19.18	Transformers ≥ IPX1 with a moulded, if any		N/A
19.19	Class I transformers with a non-detachable flexible cable or cord with earth conductor and a plug with earth contact		N/A
19.20	Live parts of SELV and PELV-circuits: separation not less than PRI/SEC of a safety isolating transformer	No other circuits than SELV on secondary side.	P
	– SELV output circuits separated by double or reinforced insulation from all other than SELV or PELV circuits		N/A
	– SELV output circuits separated by basic insulation from other SELV or PELV circuits		N/A
19.20.1	SELV circuits and parts not connected to protective earth, to live parts, or protective conductors forming part of other circuits		P
	Nominal voltage (V) > 25 V a.c. or 60 V d.c., the required insulation fulfils the high voltage test according to table 8 a		N/A
19.20.2	PELV-circuits double or reinforced insulation is necessary		N/A
19.21	FELV-circuits: protection against contact fulfils the min. test voltage required for the primary circuit		N/A
19.22	Class II transformers shall not be provided with means for protective earth		P
	For fixed transformers an earth conductor with double or reinforced insulation to accessible metal parts is allowed		N/A
19.23	Class III transformers shall not be provided with means for protective earth		N/A
20	COMPONENTS		P
	Components such as switches, plugs, fuses, lamp holders, flexible cables and cords, comply with relevant IEC standard	(see appended table 20)	P
	Components inside the transformer pass all tests of this standard together with the transformer tests		P

IEC 61558-2-16			
Clause	Requirement + Test	Result - Remark	Verdict
	Testing of components separately to the transformer according the relevant standard:		N/A
	– Ratings of the component in line with the transformer ratings, including inrush current. Component test according the component standard, based on the component marking (rating).		N/A
	– Components without markings tested under transformer conditions including inrush current.		N/A
	– If no IEC standard exists, the component is tested under transformer conditions.		N/A
20.1	Appliance couplers for main supply shall comply with:	Approved appliance inlet used.	P
	– IEC 60 320 for IPX0		P
	– IEC 60 309 for other		N/A
20.2	Automatic controls shall comply with IEC 60 730-1		N/A
20.3	Thermal-links comply with IEC 60691		N/A
20.4	Switches shall comply with annex F		N/A
	Disconnection from the supply:		N/A
	– by a switch, disconnecting all poles of the supply (full disconnection under the relevant overvoltage category		N/A
	– or a flexible supply cable and cord with plug		N/A
	– or an instruction sheet: disconnection by all-poles switches incorporated in fixed wiring		N/A
20.5	Socket-outlets of the output circuit shall be such that there is no unsafe compatibility to plugs complying with input circuit.		P
	Plugs and socket-outlets for SELV systems with both a rated current = 3A and a rated voltage =24 V shall comply with following:		P
	SELV plug and socket-outlets shall comply with IEC 60 884-2-4 and IEC 60 906-3		N/A
	– It is not possible for plugs to enter socket-outlets of other standardised voltage system		P
	– Socket outlets do not accommodate plugs of other standardised voltage systems		P
	– Socket outlets do not have a protective earth contact		P

IEC 61558-2-16			
Clause	Requirement + Test	Result - Remark	Verdict
	PELV plug and socket-outlets shall comply with following:		N/A
	– It is not possible for plugs to enter socket-outlets of other standardised voltage system		N/A
	– Socket outlets do not accommodate plugs of other standardised voltage systems		N/A
	– Socket outlets do not have a protective earth contact		N/A
	FELV plug and socket-outlets shall comply with following:		N/A
	– It is not possible for plugs to enter socket-outlets of other standardised voltage system		N/A
	– Socket outlets do not accommodate plugs of other standardised voltage systems		N/A
20.6	Thermal cut-outs, overload releases etc. have adequate breaking capacity		P
	– Thermal cut outs fulfil the relevant requirements of 20.7 and 20.8		N/A
	– Thermal links fulfil the relevant requirements of 20.8		N/A
	– The breaking capacity is in accordance with the relevant fuse standard	Approved current fuse used.	P
20.6.1	For Fuses According IEC 60127 and IEC 60269, the fuse current does not exceed 1,1 times of the rated value		P
20.7	Thermal cut outs shall meet the requirements of 20.7.1.1 and 20.7.2, or 20.7.1.2 and 20.7.2.		N/A
20.7.1	Requirements according to IEC 60730-1		N/A
20.7.1.1	Thermal cut-out tested as component shall comply with IEC 60 730-1		N/A
20.7.1.2	Thermal cut-out tested as a part of the transformer		N/A
	a) Thermal cut outs type 1 or type 2 (IEC 60730-1)		N/A
	b) Thermal cut outs fulfil the requirements of micro-interruption (type 1C or 2 C) or micro-disconnection, (type 1B or 2B) (see IEC 60730-1)		N/A
	c) Thermal cut outs with manual rest have a trip free mechanism (type 1E and 2E) (see IEC 60730-1)		N/A

IEC 61558-2-16			
Clause	Requirement + Test	Result - Remark	Verdict
	d) The number of cycles of automatic action shall be:		N/A
	– 3000 cycles for self-resetting thermal cut-outs		N/A
	– 300 cycles for non-self-resetting thermal cut-outs resetting by hand		N/A
	– 300 cycles for non-self-resetting thermal cut-outs resetting disconnecting		N/A
	– 30 cycles for non-self-resetting thermal cut-outs which are only resettable by a tool		N/A
	e) Thermal cut outs fulfil the electrical stress according IEC 60730-1, 6.14.2		N/A
	f) Characteristic of thermal cut-outs:		N/A
	– ratings according IEC 60730-1, cl. 5		N/A
	– classification according to:		N/A
	1) nature of supply to IEC 60730-1, cl. 6.1		N/A
	2) type of load controlled to IEC 60730-1, cl. 6.2		N/A
	3) degree of protection IPX0 to IEC 60730-1, cl. 6.5.1		N/A
	4) degree of protection IP0X to IEC 60730-1, cl. 6.5.2		N/A
	5) pollution degree to IEC 60730-1, cl. 6.5.3		N/A
	6) comparative tracking index to IEC 60730-1, cl. 6.13		N/A
	7) max. ambient temperature to IEC 60730-1, cl. 6.7		N/A
20.7.1.2	Thermal cut-out tested as a part of the transformer, test with 3 samples:		N/A
	– at least micro-interruption or micro-disconnection (IEC 60730-1)		N/A
	– 300 h aged at t_a (transformer) + 10°C		N/A
	– subjected to a number of cycles for automatic operating according 20.7.1.1		N/A
	During the test no sustaining arcing shall occur, during and after the test no damage at the thermal cut out and the transformer in the sense of this standard		N/A
20.7.2	Thermal cut-outs shall have adequate breaking capacity		N/A

IEC 61558-2-16			
Clause	Requirement + Test	Result - Remark	Verdict
20.7.2.1	The output of the transformer with a non-self-resetting thermal cut out is short circuited at a supply voltage 1, 1 of rated supply voltage. After opening of the cut off, the supply voltage is switched of, until the transformer is cooling down.		N/A
	– 3 cycles at 25° C for transformers without ta min		N/A
	– 3 cycles at ta min for transformers with ta min		N/A
	– after the 3 cycles short circuit of the output at 1,1 of rated supply voltage for 48 h.		N/A
	During the tests no sustaining arcing shall occur After the test: withstand the test of clause 18, show no damage in sense of this standard, and be operational.		N/A
20.7.2.2	The output of the transformer with a self-resetting thermal cut out is short circuited at a supply voltage 1, 1 of rated supply voltage.		N/A
	– 48 h at 25° C for transformers without ta min		N/A
	– 24 h at ta and 24 h at ta min for transformers with ta min		N/A
	During the tests no sustaining arcing shall occur After the test: withstand the test of clause 18, show no damage in sense of this standard, and be operational.		N/A
20.7.3	Test of a PTC resistor:		N/A
	5 cycles: transformer short-circuited for 48 h by 1,1 times of the input voltage and max. ta		N/A
	5 cycles: transformer short-circuited for 48 h by 0,9 times of the input voltage and min. ta (if declared)		N/A
	After the test: withstand the test of clause 18, show no damage in sense of this standard, and be operational.		N/A
20.8	Thermal links shall be tested in one of the following two ways.		N/A
20.8.1	Thermal-links shall comply with IEC 60 691 as a separate component.		N/A
	– electrical conditions to IEC 60691, cl. 6.1		N/A
	– thermal conditions to IEC 60691, cl. 6.2		N/A
	– ratings to IEC 60691, cl. 8 b		N/A

IEC 61558-2-16			
Clause	Requirement + Test	Result - Remark	Verdict
	– suitability of sealing components, impregnating fluids or cleaning solvents IEC 60691, cl. 8 c		N/A
20.8.2	Thermal-links tested as a part of the transformer:		N/A
	– ageing test 300 h by 35 °C or ta + 10 °C		N/A
	– After transformer fault condition the thermal link operate without sustaining arcing		N/A
	– after opening the thermal-link shall have an insulation resistance of at least 0,2 M		N/A
	– 3 cycles for replaceable thermal-links		N/A
	– 3 new specimens for not replaceable thermal-links		N/A
20.9	Self-resetting devices not used if mechanical, electrical, etc. hazards		N/A
20.10	Thermal cut-outs which can be reset by soldering operation are not allowed		N/A
20.11	Overload protection devices do not operate during test (20 times switched on and off, at no load); Upri (V): 1,1 times rated supply voltage.		P

21	INTERNAL WIRING		P
21.1	Internal wiring and electrical connections protected or enclosed		P
	Wire-ways smooth and free from sharp edges		P
21.2	Openings in sheet metal: edges rounded (radius 1,5 mm) or bushings of insulating material		N/A
21.3	Bare conductors: distances adequately maintained		P
21.4	When external wires are connected to terminal, internal wiring shall not work loose		N/A
21.5	Insulation of heat-resistant and non-hygroscopic material for insulated conductors subject to temperature rise > limiting values given in 14.1		N/A

22	SUPPLY CONNECTION AND EXTERNAL FLEXIBLE CABLES AND CORDS		P
22.1	All cables, flexible cords etc. shall have appropriate current and voltage ratings	Inlet provided. No detachable cord supplied.	P
22.2	Input and output wiring inlet and outlet openings for external wiring: separate entries without damage to protective covering of cable or cord		P

IEC 61558-2-16			
Clause	Requirement + Test	Result - Remark	Verdict
	Input and output wiring inlet and outlet openings for flexible cables or cords: insulating material or bushing of insulating material		P
	Bushings for external wiring: reliably fixed, not of rubber unless part of cord guard		P
22.3	Fixed transformer:		N/A
	– possible to connect after fixing		N/A
	– inside space for wires allow easy introduction and connection of conductors		N/A
	– fitting of cover without damage to conductors		N/A
	– contact between insulation of external supply wires and live parts of different polarity not allowed		N/A
22.4	Length of power supply cord for portable transformers between 2 m and 4 m; without 0,5 mm ²	Power cord not provided.	N/A
22.5	Power supply cords for transformers IPX0 and transformers "for indoor use only" ≥ IPX0:		N/A
	– for transformers with a mass ≤ 3 kg: 60227 IEC52 (H03VV-..) (60245 IEC 53)		N/A
	– for transformers with a mass > 3 kg: 60227 IEC53 (H05VV-..) or 60245 IEC 53		N/A
	Power supply cords for transformers for outdoor use: ≥ IPX0: 60245 IEC57 (H05RN-..)		N/A
22.6	Power supply cords for single-phase portable transformers with input current 16A:		N/A
	– cord set fitted with an appliance coupler in accordance with IEC 60320		N/A
22.7	Nominal cross-sectional area (mm ²); input current (A) at rated output not less than shown in table 9		N/A
22.8	Class I transformer with power supply flexible cable: green/yellow core connected to earth terminal		N/A
	Plug for single-phase transformer with input current at rated output 16 A according to IEC 60 083, IEC 60 906-1 or IEC 60 309		N/A
22.9	Type X, Y or Z attachments: see relevant part 2		P
22.9.1	For type Z attachment: moulding enclosure and power supply cable do not affect insulation of cable	Output cord	P
22.9.2	Inlet openings or inlet bushing: without risk of damage to protective covering of power supply cord		N/A

IEC 61558-2-16			
Clause	Requirement + Test	Result - Remark	Verdict
	Insulation between conductor and enclosure:		N/A
	– for Class I transformer: insulation of conductor plus separate basic insulation		N/A
	– for Class II transformer: insulation of conductor plus double or reinforced insulation		N/A
22.9.3	Inlet bushings:		N/A
	– no damage to power supply cord		N/A
	– reliably fixed		N/A
	– not removable without tool		N/A
	– not integral with power supply cord (for type X attachment)		N/A
	– not of natural rubber except for Class I transformer with type X, Y and Z attachments		N/A
22.9.4	For portable transformers which are moved while operating:		N/A
	– cord guards, if any, of insulating material and fixed		N/A
	Compliance is tested by the oscillating test according to fig. 7:		N/A
	– loaded force during the test according to fig. 7		N/A
	– 10 N for a cross-sectional area > 0,75		N/A
	– 5 N for a cross-sectional area 0,75		N/A
	After the test according to fig. 7:		N/A
	– no short-circuit between the conductors		N/A
	– no breakage of more than 10% of strands of any conductor		N/A
	– no separation of the conductor from the terminal		N/A
	– no loosening of any cord guards		N/A
	– no damage of the cord or cord guard		N/A
	– no broken strands piercing the insulation and not becoming accessible		N/A
22.9.5	Cord anchorages for type X attachment:		N/A
	– glands in portable transformers not used unless possibility for clamping all types and sizes of cable		N/A

IEC 61558-2-16			
Clause	Requirement + Test	Result - Remark	Verdict
	– moulded-on designs, tying the cable into a knot and tying the end with string not allowed		N/A
	– labyrinths, if clearly how, permitted		N/A
	– replacement of cable easily possible		N/A
	– protection against strain and twisting clearly how		N/A
	– suitable for different types of cable unless only one type of cable for transformer		N/A
	– the entire flexible cable or cord with covering can be mounted into the cord anchorage		N/A
	– if tightened or loosened no damage		N/A
	– no contact between cable or cord and accessible or electrically connected clamping screws		N/A
	– cord clamped by metal screw not allowed		N/A
	– one part securely fixed to transformer		N/A
	– for Class I transformer: insulating material or insulated from metal parts		N/A
	– for Class II transformers: insulating material or supplementary insulation from metal parts		N/A
	Cord anchorages for type X, Y, Z attachments: cores of power external flexible cable or cord insulated from accessible metal parts by:		N/A
	– basic insulation (Class I transformers), separate insulating barrier/cord anchorage		N/A
	– supplementary insulation (Class II transformers), special lining/cable or cord sheath of cable sheath of cable		N/A
	Cord anchorages for type X and Y attachments:		N/A
	– replacement of external flexible cable or cord does not impair compliance with standard		N/A
	– the entire flexible cable or cord with covering can be mounted into the cord anchorage		N/A
	– if tightened or loosened no damage		N/A
	– no contact between cable or cord and accessible or electrically connected clamping screws		N/A

IEC 61558-2-16			
Clause	Requirement + Test	Result - Remark	Verdict
	– cord clamped by metal screws not allowed		N/A
	– knots in cord not used		N/A
	– labyrinths, if clearly how, permitted		N/A
	Tests for type X with special cords, type Y, type Z	Tested for output cord.	P
	Test for type X attachments one test with a cord with smallest and one test with a cord with the largest cross-sectional area:		N/A
	– for the test with clamping screws or tightened with torque 2/3 of that specified in table 11		P
	– not possible to push cable into transformer		P
	– 25 pulls of 1 s		P
	– 1 min torque according to table 10		P
	– mass (kg); pull (N); torque (Nm)	Mass of product: ≤1kg 30N, 0.1Nm applied.	—
	– during test: cable not damaged		P
	– after test: longitudinal displacement 2 mm for cable or cord and 1 mm for conductors in terminals		P
	– creepage distances and clearances values specified in Cl. 26		P
22.9.6	Space for external cords or cable for fixed wiring and for type X and Y attachments:		N/A
	– before fitting cover, possibility to check correct connection and position of conductors		N/A
	– cover fitted without damage to supply cords		N/A
	– for portable transformers: contact with accessible metal parts if conductor becomes loose not allowed unless for type X and Y attachments terminations of cords do not slip free of conductor		N/A
	Space for external cords or cable for type X attachment and for connection to fixed wiring, in addition:		N/A
	– conductor easily introduced and connected		N/A
	– possibility of access to terminal for external conductor after removal of covers without special purpose tool		N/A

IEC 61558-2-16			
Clause	Requirement + Test	Result - Remark	Verdict
23	TERMINALS FOR EXTERNAL CONDUCTORS		P
23.1	Transformer for connection to fixed wiring and transformer without power supply cords with type Y and Z attachments: only connections by screws, nuts, terminals		P
	Terminals are integral part of the transformer:		N/A
	– comply with IEC 60 999-1 under transformer conditions		N/A
	Other terminals:		N/A
	– separately checked according to IEC 60 998-2-1, IEC 60 998-2-2 or IEC 60 947-7-1		N/A
	– used in accordance with their marking		N/A
	– checked according to IEC 60 999-1 under transformer conditions		N/A
	Transformer with type X attachments: soldered connection permitted if reliance not placed upon soldering, crimping or welding alone unless by barriers, creepage distances and clearances between hazardous live parts and metal parts should conductor break away 50% of specified value (Cl. 26)		N/A
	Transformer with type Y and Z attachments for external conductors: soldered, welded, crimped, etc. connections allowed		N/A
	For Class II transformer: reliance not placed upon soldering, crimping or welding alone unless by barriers, creepage distances and clearances between hazardous live parts and metal parts should conductor break away 50% of specified value (Cl. 26)		N/A
23.2	Terminals for type X with special cords Y and Z attachments shall be suitable for their purpose:	For output cord.	P
	– test by inspection according to 23.1 and 23.2		P
	– pull of 5 N to the connection before test according to 14.1		P
23.3	Other terminals than Y and Z attachments shall be so fixed that when the clamping means is tightened or loosened:		N/A
	– terminal does not work loose		N/A
	– internal wiring is not subjected to stress		N/A

IEC 61558-2-16			
Clause	Requirement + Test	Result - Remark	Verdict
	– creepage distances and clearance are not reduced below the values specified in Cl. 26		N/A
23.4	Other terminals than Y and Z attachments shall be so designed that:		N/A
	– they clamp the conductor between metallic surfaces with sufficient contact pressure		N/A
	– without damage to the conductor		N/A
	– test by inspection according to 23.3 and 23.4		N/A
	– 10 times fastening and loosening a conductor with the largest cross-sectional area with 2/3 of the torque specified in Cl. 25		N/A
23.5	Terminals for fixed wiring and for type X: located near their associated terminals of different polarities and the earth terminal if any		N/A
23.6	Terminal blocks not accessible without the aid of a tool		N/A
23.7	Transformer with type X attachments: stranded conductor test (8 mm removed):		N/A
	– Class I transformers: no connection between live parts and accessible metal parts		N/A
	– free wire of earth terminal: no touching of live parts		N/A
	– Class II transformers: no connection between live parts and accessible metal parts, no connection between live parts and metal parts separated from accessible metal parts by supplementary insulation		N/A
23.8	Terminals for a current > 25 A:		N/A
	– pressure plate, or		N/A
	– two clamping screws		N/A
23.9	When terminal, other than protective earth conductor, screws loosened as far as possible, no contact:		N/A
	– between terminal screws and accessible metal parts		N/A
	– between terminal screws and inaccessible metal parts for Class II transformers		N/A
24	PROVISION FOR PROTECTIVE EARTHING		P

IEC 61558-2-16			
Clause	Requirement + Test	Result - Remark	Verdict
24.1	Class I transformers: accessible conductive parts connected to earth terminal		N/A
	Class II transformers: no provision for earth		P
24.2	Protective earth terminal for connection to fixed wiring and for type X attachment transformers: comply with Cl. 23, adequately locked, not possible to loosen without a tool		N/A
24.3	No risk of corrosion from contact between metal of earth terminal and other terminal		N/A
	In case of earth terminal body of Al, no risk of corrosion from contact between Cu and Al		N/A
	Body of earth terminal or screws/nuts of brass or other metal resistant to corrosion		N/A
24.4	Resistance of connection between earth terminal and metal parts 0,1 with a min. 25 A or 1,5 rated input current at 1 min		N/A
24.5	Class I transformers with external flexible cables or cords:		N/A
	– current-carrying conductors becoming touch before the earth conductor		N/A

25	SCREWS AND CONNECTIONS		N/A
25.1	Screwed connections withstand mechanical stresses	No screw	N/A
	Screws transmitting contact pressure or likely to be tightened by the user or having a diameter < 2,8 mm, shall screw into metal		N/A
	Screws not of metal which is soft or liable to creep (Zn, Al)		N/A
	Screws of insulating material: not used for electrical connection		N/A
	Screws not of insulating material if their replacement by metal screws can impair supplementary or reinforced insulation		N/A
	Screws to be removed (replacement etc. of power supply cord) not of insulating material if their replacement by metal screws can impair basic insulation		N/A
	No damage after torque test: diameter (mm); torque (Nm); ten times		N/A
	No damage after torque test: diameter (mm); torque (Nm); five times		N/A

IEC 61558-2-16			
Clause	Requirement + Test	Result - Remark	Verdict
25.2	Screws in engagement with thread of insulating material:		N/A
	– length of engagement 3 mm + 1/2 screw diameter or 8 mm		N/A
	– correct introduction into screw hole		N/A
25.3	Electrical connections: contact pressure not transmitted through insulating material		N/A
25.4	In case of use of thread-forming (sheet metal) screws for connection of current-carrying parts: clamping and locking means provided		N/A
	Thread-cutting (self-tapping) screws used for the connection of current-carrying parts allowed if they generate a full form machine screw thread and if not operated by the user		N/A
	Thread-cutting screws and thread-forming screws used for earth continuity allowed if at least 2 screws for each connection are used and it is not necessary to disturb the connection in normal use		N/A
25.5	Screws for current-carrying mechanical connections locked against loosening		N/A
	Rivets for current-carrying connections subject to torsion locked against loosening		N/A
25.6	Test of screwed glands with a torque according table 12. After the test no damage at the transformer and the gland.		N/A

26	CREEPAGE DISTANCES AND CLEARANCES		P
26.1	See 26.101		P
26.2	Creepage distances (cr) and clearances (cr)	See cl.26.101	P
26.2.1	Windings covered with adhesive tape		N/A
	– the values of pollution degree 1 are fulfilled		N/A
	– all isolating material are classified acc. to IEC 60085 and IEC 60216		N/A
	– test A of 26.2.3 is fulfilled		N/A
26.2.2	Uncemented insulating parts pollution degree P2 or P3		P
	– all isolating material are classified acc. to IEC 60085 and IEC 60216		P
	– values of pollution degree 1 are not applicable		P
26.2.3	Cemented insulating parts		N/A

IEC 61558-2-16			
Clause	Requirement + Test	Result - Remark	Verdict
	– all isolating materials are classified acc. to IEC 60085 and IEC 60216		N/A
	– values of distance through insulation (dti) are fulfilled		N/A
	– creepage distances and clearances are not required		N/A
	– test A of this sub clause is fulfilled		N/A
	Test A		N/A
	– thermal class		N/A
	– working voltage		N/A
	– Test with three specially specimens, with uninsulated wires, without impregnation or potting		N/A
	Two of the three specimens are subjected to:		N/A
	– the relevant humidity treatment according to 17.2 (48 h)		N/A
	– the relevant dielectric strength test of 18.3 multiplied with factor 1,35		N/A
	– One of the three specimens is subjected to the relevant dielectric strength test of 18.3 multiplied by the factor 1,35 immediately at the end of the last cycle with high temperature		N/A
	Impulse dielectric test according to 4.1.1.2.1 of IEC 60 664-1 (1,2 / 50 s waveform) – see Annex R of IEC 61558-1		N/A
26.2.4	Enclosed parts, by impregnation or potting		N/A
26.2.4.1	– The requirements of reduced values as stated for pollution degree 1 (P1) are fulfilled		N/A
	– all isolating materials are classified acc. to IEC 60085 and IEC 60216		N/A
	Test B		N/A
	– thermal class		N/A
	– working voltage		N/A
	– Test with three specially specimens, potted or impregnated. The dielectric strength test is applied directly to the joint.		N/A
	Two of the three specimens are subjected to:		N/A

IEC 61558-2-16			
Clause	Requirement + Test	Result - Remark	Verdict
	– the relevant humidity treatment according to 17.2 (48 h)		N/A
	– the relevant dielectric strength test of 18.3 multiplied with factor 1,25		N/A
	– One of the three specimens is subjected to the relevant dielectric strength test of 18.3 multiplied by the factor 1,25 immediately at the end of the last cycle with high temperature		N/A
	The three spacemen pass the Impulse dielectric test according to 4.1.1.2.1 of IEC 60 664-1 (1,2 / 50 s waveform) – see Annex R of IEC 61558-1		N/A
26.2.4.2	– The requirements of distance through insulation (dti) are fulfilled. (P1 values are not required)		N/A
	– all isolating materials are classified acc. to IEC 60085 and IEC 60216		N/A
	Test C		N/A
	– thermal class		N/A
	– working voltage		N/A
	– Test with three specimens, potted or impregnated. (finished components)		N/A
	– Neither cracks, nor voids in the insulating compounds		N/A
	Two of the three specimens are subjected to:		N/A
	– the relevant humidity treatment according to 17.2 (48 h)		N/A
	– the relevant dielectric strength test of 18.3 multiplied with factor 1,35		N/A
	– One of the three specimens is subjected to the relevant dielectric strength test of 18.3 multiplied by the factor 1,35 immediately at the end of the last cycle with high temperature		N/A
	The three spacemen pass the Impulse dielectric test according to 4.1.1.2.1 of IEC 60 664-1 (1,2 / 50 s waveform) – see Annex R of IEC 61558-1		N/A
26.3	Distance through insulation		P
	For double or reinforced insulation, the required values of Tables 13, C1, and D1 – boxes 2b, 2c and 7 are fulfilled	Dti of enclosure is min.2.5mm (required: ≥1.0mm)	P

IEC 61558-2-16			
Clause	Requirement + Test	Result - Remark	Verdict
	The insulation fulfil the material classification according IEC 60085 or 60216 or the test of 14.3		P
26.3.1	Reduced values of the thickness of insulation for supplementary or reinforced insulation are allowed if the following conditions are fulfilled:		P
	– the isolating materials are classified acc. to IEC 60085 and IEC 60216		N/A
	– the test of 14.3 is fulfilled		N/A
	– If both requirements are fulfilled, the required values for solid insulation can be multiplied by 0,4		N/A
	– Minimum thickness of reinforced insulation $\geq 0,2$ mm		N/A
	– Minimum thickness of supplementary insulation $\geq 0,1$ mm		N/A
26.3.2	Insulation in thin sheet form		P
	– If the layers are non-separable (glued together):		N/A
	– The requirement of 3 layers is fulfilled		N/A
	– The mandrel test according 26.3.3 is fulfilled with 150 N		N/A
	– The required values for d.t.i. of Tables 13, C.1 and D.1 – marked by index "e" is fulfilled.		N/A
	– If the layers are separated:		N/A
	– The requirement of 2 layers is fulfilled		N/A
	– If serrated tape is used, 1 additional layer (serrated) and one additional layer without serration is required		N/A
	– The mandrel test according 26.3.3 is fulfilled on each layer with 50 N		N/A
	– The required values for d.t.i. of Tables 13, C.1 and D.1 – marked by index "e" is fulfilled.		N/A
	– If the layers are separated (alternative:		P
	– The requirement of 3 layers is fulfilled	Three layers of insulation tape on T1 core considered as supplementary insulation.	P

IEC 61558-2-16			
Clause	Requirement + Test	Result - Remark	Verdict
	– If serrated tape is used, 1 additional layer (serrated) and one additional layer without serration is required		N/A
	– The mandrel test according 26.3.3 is fulfilled on 2/3 of the layers with 100 N		P
	– The required values for d.t.i. of Tables 13, C.1 and D.1 – marked by index "e" is fulfilled.		P
	Test according to 14.3 and if the isolating materials are classified acc. to IEC 60085 and IEC 60216 no distances through insulation are required for insulation in thin sheet form		N/A
	The figures within square brackets in box 2 and 7 of table 13 (C.1/D.1) are used for insulation in thin sheet form as follows:		P
	– rated output > 100 VA values in square brackets apply		P
	– rated output 25 VA 100 VA 2/3 of the value in square brackets apply		N/A
	– rated output 25 VA 1/3 of the value in square brackets apply		N/A
26.3.3	Mandrel test of insulation in thin sheet form (specimen of 70 mm width are necessary):		P
	– If the layers are non-separable – at least 3 layers glued together fulfil the test:		N/A
	– pull force of 150 N		N/A
	– high voltage test of 5,0 kV or the test voltage of 18.3 multiplied by 1,25 whatever is the greater. No flashover, no breakdown.		N/A
	– If the layers are separable and 2/3 of at least 3 layers fulfil the test.	3 layers	P
	– pull force of 100 N		P
	– high voltage test of 5,0 kV or the test voltage of 18.3 multiplied by 1,25 whatever is the greater. No flashover, no breakdowns.		P
	– If the layers are separable 1 of at least 2 layers fulfil the test:		N/A
	– pull force of 50 N		N/A

IEC 61558-2-16			
Clause	Requirement + Test	Result - Remark	Verdict
	– high voltage test of 5,0 kV or the test voltage of 18.3 multiplied by 1,25 whatever is the greater. No flashover, no breakdown.		N/A
26.101	Creepage distances, clearances and distances through insulation, specified values according to (EN 61558-2-16:09):		P
	– table 13, material group IIIa (part 1)		P
	– table C, material group II (part 1)		N/A
	– table D, material group I (part 1)		N/A
	– working voltage	Max. 262Vrms across primary and secondary terminal on transformer.	P
	– rated supply frequency 50/60 Hz		N/A
	– rated internal frequency		P
	1. Insulation between input and output circuits (basic insulation):		
	a) measured values \geq specified values (mm)		N/A
	2. Insulation between input and output circuits (double or reinforced insulation):		P
	a) measured values \geq specified values (mm)	(see appended table 26)	P
	b) measured values \geq specified values (mm)		N/A
	c) measured values \geq specified values (mm)		N/A
	3. Insulation between adjacent input circuits: measured values \geq specified values (mm) :		N/A
	Insulation between adjacent output circuits: measured values \geq specified values (mm) ..		N/A
	4. Insulation between terminals for external connection:		N/A
	a) measured values \geq specified values (mm)		N/A
	b) measured values \geq specified values (mm)		N/A
	c) measured values \geq specified values (mm)		N/A
	5. Basic or supplementary insulation:		P

IEC 61558-2-16			
Clause	Requirement + Test	Result - Remark	Verdict
	a) measured values \geq specified values (mm)	(see appended table 26)	P
	b) measured values \geq specified values (mm)		N/A
	c) measured values \geq specified values (mm)		N/A
	d) measured values \geq specified values (mm)	(see appended table 26)	P
	e) measured values \geq specified values (mm)		N/A
	6. Reinforced or double insulation: measured values specified values (mm)	(see appended table 26)	P
	7. Distance through insulation:		P
	a) measured values \geq specified values (mm)		N/A
	b) measured values \geq specified values (mm)	see appended table 26)	P
	c) measured values \geq specified values (mm)	see appended table 26)	P
26.102	Values of IEC 61558-2-16 applicable for frequency up to 3 MHz (EN 61558-2-16:09)		P
	For frequency above 3 MHz clause 7 of IEC 60664-4 is applicable (high frequency testing)		N/A
26.103	Clearance (EN 61558-2-16:09)		P
	a) Clearance for frequency \geq 30 kHz according figure 101 two determinations are necessary:		P
	– determination based on peak working voltage according Table 104 :		P
	Peak working voltage	415V _{peak}	P
	Basic insulation: required / measured		N/A
	Double or reinforced insulation: required / measured value		N/A
	– and alternative if applicable for approximately homogeneous field according to Table 102		N/A
	Peak working voltage		N/A
	Basic insulation: required / measured		N/A
	Double or reinforced insulation: required / measured value		N/A

IEC 61558-2-16			
Clause	Requirement + Test	Result - Remark	Verdict
	– determination based on measured r.m.s. working voltage according Tables 13, C1 and D1 (see clause 26.101)	See 26.101	P
	The minimum clearance is the greater of the two values.	See 26.101	P
	b) Clearance for frequency ≤ 30 kHz according figure 101 two determinations are necessary:		N/A
	– determination based on peak working voltage with recurring peak voltages according Table 103 :		N/A
	– determination based on measured r.m.s. working voltage according Tables 13, C1 and D1 (see clause 26.101)		N/A
	The minimum clearance is the greater of the two values.		N/A
26.104	The working voltages of Table 102, 103 and 104 are peak voltages including μ sec peaks (EN 61558-2-16:09)		N/A
	The working voltage according to Table 13 of part 1 are r.m.s. voltages		N/A
26.105	Creepage distances		N/A
	Two determinations of creepage distances are necessary (see Figure 102)		N/A
	– determination based on measured peak working voltage according Tables 105 to 110		N/A
	Peak working voltage		N/A
	Pollution degree		N/A
	Basic or supplementary insulation: required / measured		N/A
	Double or reinforced insulation: required / measured value		N/A
	– determination based on measured r.m.s. working voltage according Tables 13, C1 and D1 (see clause 26.101)		N/A
	If the values based on table 105 to 110 are lower than the relevant values in Tables 13, C.1 or D.1, the higher values shall be applicable		N/A
26.106	Distance through insulation (EN 61558-2-16:09)		N/A
	Instead of partial discharge with high frequency voltage the test of the distance and the calculation of the electric field is applicable under the following conditions:		N/A

IEC 61558-2-16			
Clause	Requirement + Test	Result - Remark	Verdict
	– the max. frequency is < 10 MHz		N/A
	– the field strength approximately comply with Figure 103		N/A
	– no voids or gaps are present in between the solid insulation		N/A
	For thick layers $d1 \geq 0,75$ the peak value of the field strength is ≤ 2 kV/mm		N/A
	For thin layers $d2 \leq 30 \mu\text{m}$ the peak value of the field strength is ≤ 10 kV/mm		N/A
	For $d1 > d > d2$ equation (1) is used for calculation the field strength		N/A
26.107 (A1)	For transformers with FIW wires the following test is required		N/A
	– 10 cycles are required		N/A
	– 68 h test at max heating temperature + 10°C or test at max. allowed winding temperature based on the insulation class (required in table 1) + 10°C		N/A
	– 1 h at 25° C		N/A
	– 2 h at 0° C		N/A
	– 1 h at 25° C – (next cycle start again with 68 h max winding temp + 10)		N/A
	– during the 10 cycles test 2 x working voltage is connected between PRI and SEC		N/A
	– after 10 cycle test 2 transformers are subjected to the 17.2 test for 48 h and direct after the 48 h the dielectric strength test of 18.3 (100 % test voltage) is done		N/A
	– after the 10 cycle test the third sample is tested at the end of the last cycle in the hot position with the dielectric strength test of 18.3 (100 % test voltage)		N/A
	– the partial discharge test according to 18.101 is done after the cycling test and after the high voltage test, if the peak working voltage is >750 V		N/A
27	RESISTANCE TO HEAT, FIRE AND TRACKING		P
27.1	Resistance to heat		P
	All insulating parts are resistant to heat		P

IEC 61558-2-16			
Clause	Requirement + Test	Result - Remark	Verdict
	For parts of rubber, which passed the test of 19.9, no additional test is required.		N/A
	The tests are not required for cables and small connectors with a rated current ≤ 3 A, a rated voltage ≤ 24 V a.c. or 60 V d.c. and a power ≤ 72 W		N/A
27.1.1	External accessible parts		P
	The Ball-pressure test -: diameter of impression ≤ 2 mm; heating cabinet temperature ($^{\circ}$ C) at 70° C or the temperature T of 14.1 (T + 15) - is fulfilled.	Enclosure material: 88° C Impression: 1.1mm	P
27.1.2	Internal parts		P
	For insulating material retaining current carrying parts in position , the ball-pressure test -: diameter of impression ≤ 2 mm; heating cabinet temperature ($^{\circ}$ C) at 125° C or the temperature T of 14.1 (T + 15) - is fulfilled	PCB: 125° C; 0.8mm L1 Bobbin: 125° C; 1.1mm T3 bobbin: 125° C; 1.0mm T2 bobbin: 125° C; 1.1mm Output connector: 125° C; 1.2mm	P
27.2	Resistance to abnormal heat under fault conditions		N/A
27.3	Resistance to fire		P
	All isolating parts of the transformer shall be resistant to ignition and spread of fire. The test according to IEC 60696-2-10 is required		P
27.3.1	External accessible parts (glow wire tests)		P
	– 650° C for enclosures	Enclosure	P
	– 650° C for parts retaining current carrying parts in position and terminals for external conductors Current $\leq 0,2$ A		N/A
	– 750° C for parts retaining current carrying parts in position and terminals for external conductors with fixed wiring. Current $> 0,2$ A		N/A
	– 850° C for parts retaining current carrying parts in position and terminals for external conductors with non-fixed wiring. Current $> 0,2$ A	Output connector	P
27.3.2	Internal parts		P
	– 550° C for internal insulating material – not retaining current carrying parts in position		N/A
	– 650° C for coil formers (bobbins)	T3 Bobbin T2 bobbin L1 Bobbin	P

IEC 61558-2-16			
Clause	Requirement + Test	Result - Remark	Verdict
	– 650 °C for parts retaining current carrying parts in position and terminals for external conductors. Current $\leq 0,2$ A		N/A
	– 750 °C for parts retaining current carrying parts in position and terminals for external conductors with fixed wiring. Current $> 0,2$ A		N/A
	– 850 °C for parts retaining current carrying parts in position and terminals for external conductors with non-fixed wiring. Current $> 0,2$ A	PCB Output connector	P
27.4	For IP other than IPX0: If insulating parts retaining current carrying parts in position and under P3 conditions, the material resistance to tracking is at least material of group IIIa		N/A
	Test (175 V): no flashover or breakdown before 50 drops		N/A

28	RESISTANCE TO RUSTING		P
	Ferrous parts protected against rusting		P

E	ANNEX E , GLOW WIRE TEST		P
	The test is required according to IEC 60695-2-10 and IEC 60695-2-11 with the following additions:		P
E.1	Clause 6, "Severities" of IEC 6095-2-11, apply with the temperature stated in 27.3 of IEC 61558-1		P
E2	Clause 8, "Conditioning", of IEC 60695-2-11 apply, preconditioning is required		P
E3	Clause 10, "Test Procedure", of IEC 60695-2-11 apply, The tip of the glow wire is applied to the flat side of the surface.		P

F	ANNEX F, REQUIREMENTS FOR MANUALLY OPERATED SWITCHES WHICH ARE PARTS OF THE TRANSFORMER		N/A
F.2	Manually operated mechanical switches, tested as separate component, shall comply with IEC 61058 under the conditions of F2.		N/A
F.§	Manually operated mechanical switches tested as part of the transformer shall comply with the conditions specified under F.3		N/A

IEC 61558-2-16			
Clause	Requirement + Test	Result - Remark	Verdict
H	ANNEX H, ELECTRONIC CIRCUITS (IEC 61558-1)		P
H1	General notes on tests (addition to clause 5)		P
H.2	SHORT-CIRCUIT AND OVERLOAD PROTECTION (ADDITION TO CLAUSE 15)		P
H.2.1	Circuits designed and applied so that fault conditions do not render the appliance unsafe		P
	During and after each test:		P
	– temperatures do not exceed values specified in table 3 of Cl. 15.1		P
	– transformer complies with conditions specified in sub-clause 15.1		P
	If a conductor of a pcb becomes open circuited, the transformer is considered to have withstood the particular test, provided that all six conditions as specified are met		N/A
H.2.2	Fault conditions a) to f) of sub-clause H.2.3 are not tested if the following conditions are met:		N/A
	– electronic circuit is a low-power circuit as specified		N/A
	– safety of the appliance as specified does not rely on correct functioning of the electronic circuit		N/A
H.2.3	Fault conditions tested as specified when relevant:		P
	a) short-circuit of creepage distances and clearances, if less than specified in Cl. 26	See only test of c) to e)	N/A
	b) open circuit at the terminals of any component		P
	c) short-circuit of capacitors, unless they comply with IEC 60 384-14		P
	d) short-circuit of any two terminals of an electronic component as specified		P
	e) any failure of an integrated circuit as specified		P
	f) low-power circuit: low-power points are connected to the supply source		N/A
	Cl. 15 is repeated with a simulated fault as indicated in a) to e), if the transformer incorporates an electronic circuit to ensure compliance with Cl. 15	Unit shut down for all fault condition test. See appended table H.2.3	N/A
	Fault condition e) is applied for encapsulated and similar components		N/A

IEC 61558-2-16			
Clause	Requirement + Test	Result - Remark	Verdict
	PTC's and NTC's are not short-circuited if they are used as specified		N/A
H.2.4	If for a fuse-link complying with IEC 60 127-3 rated fuse current I1 is used, current I2 is measured as specified:		P
	– if $I2 < 2,1 \times I1$ test of 15.8 is repeated with fuse-link short-circuited		N/A
	– if $I2 > 2,75 \times I1$, no other tests are necessary		P
	If $I2 > 2,1 \times I1$ and $I2 < 2,75 \times I1$ test of 15.8 is repeated as specified		N/A
	For fuses other than those complying with IEC 60 127-3, the test is carried out as specified 15.3.2 to 15.3.5		N/A

H.3	CREEPAGE DISTANCES, CLEARANCES AND DISTANCES THROUGH INSULATION		P
H.3.1	For live parts separated by basic insulation smaller cr and cl as in 26 are allowed, if H2 is fulfilled.	For secondary circuits and parts protected by fuse.	P
	In optocouplers no requirements of cr and cl	Approved optocoupler used	P
	For coatings annex W applies. Smaller distances as required in IEC 60664-3, clause 4 are applicable,		N/A
	For potted transformers cycling tests acc, 26.2. are applicable		N/A
H.3.2	The ma. surface temperature of optocouplers is 50 K		P

K (A1)	ANNEX K, INSULATED WINDING WIRES FOR USE AS MULTIPLE LAYER INSULATION		P
K.1	Wire construction:		P
	insulated winding wire for basic or supplementary insulation (see 19.12.3)		N/A
	insulated winding wire for reinforced insulation (see 19.12.3)	VDE approved triple insulated wire	P
	split circular winding wires and stranded winding wires with 0,05 to 5 mm diameter		P
	spirally wrapped insulation – overlapping		N/A
K.2	Type tests		N/A



IEC 61558-2-16			
Clause	Requirement + Test	Result - Remark	Verdict
K.2.1	General Tests between ambient temperature between 15° C and 35° C and at an humidity between 45% and 75 %		N/A
K.2.2	Electric strength test		N/A
K.2.2.1	Solid circular winding wires and stranded winding wires		N/A
	Test samples prepared according to clause 4.4.1 of IEC 60851-5:2008 (twisted pair)		N/A
	Dielectric strength test: 6 kV for reinforced insulation		N/A
	Dielectric strength test: 3 kV for basic or supplementary insulation		N/A
K.2.2.2	Square or rectangular wires .		N/A
	Test samples prepared according to clause 4.7.1 of IEC 60851-5:2008		N/A
	Dielectric strength test: 5,5 kV for reinforced insulation		N/A
	Dielectric strength test: 2,75 kV for basic or supplementary insulation		N/A
K.2.3	Flexibility and adherence		N/A
	Claus 5.1 in Test 8 of IEC 60851-3:2009 shall be used		N/A
	Test samples prepared according to clause 5.1.1.4 of IEC 60851-3:2009		N/A
	Dielectric strength test: 5,5 kV for reinforced insulation		N/A
	Dielectric strength test: 2,75 kV for basic or supplementary insulation		N/A
	Mandrel diameter according table K.1		N/A
	The tension to the wire during winding on mandrel is 118 N/mm ² (118 MPa)		N/A
K.2.4	Heat shock		N/A
	Test samples prepared according to 3.1.1 (in Test 9) of IEC 60851-6:1996		N/A
	high voltage test immediately after this test		N/A
	Dielectric strength test: 5,5 kV for reinforced insulation		N/A
	Dielectric strength test: 2,75 kV for basic or supplementary insulation		N/A

IEC 61558-2-16			
Clause	Requirement + Test	Result - Remark	Verdict
K.2.5	Retention of dielectric strength after bending (test as specified under test 13 of 4.6.1 c) of IEC 60 851-5)		N/A
			N/A
	high voltage test immediately after this test		N/A
	Dielectric strength test: 5,5 kV for reinforced insulation		
	Dielectric strength test: 2,75 kV for basic or supplementary insulation		
K.3.1	General Tests as subjected in K.3.2 and K.3.3		N/A
K.3.2	Routine test		N/A
	Dielectric strength test: 4,2 kV for reinforced insulation		N/A
	Dielectric strength test: 2,1 kV for basic or supplementary insulation		N/A
K.3.3	Sampling test		N/A
K.3.3.1	Solid circular winding wires and stranded winding wires		N/A
	Test with a twisted pair, prepared according clause 4.4.1 of IEC 60851-5:2008		N/A
	Dielectric strength test: 6 kV for reinforced insulation		N/A
	Dielectric strength test: 3 kV for basic or supplementary insulation		N/A
K.3.3.2	Square rectangular wire		N/A
	Samples prepared according to clause 4.7.1 of IEC 60851-5:2008		N/A
	Dielectric strength test: 5,5 kV for reinforced insulation		N/A
	Dielectric strength test: 3 kV for basic or supplementary insulation		N/A

U	ANNEX U – INFORMATIVE – OPTIONAL TW – MARKING FOR TRANSFORMERS		N/A
	The tests of Annex U are based on constant S = 4500. Other constants are possible, if the test of U.5.2 is done with positive result.		N/A
U1	General notes and tests		N/A
	8 transformers of one type are necessary for the test. Tests according U5.		N/A

IEC 61558-2-16			
Clause	Requirement + Test	Result - Remark	Verdict
U.2	Heating (addition to clause 14)		N/A
14.4	Thermal endurance test		N/A
	Test according U5 and measurements according 11.1		N/A
	Transformers tested as an integral part of the equipment (option), assigned with tw		N/A
	The thermal conditions are so adjusted, that the duration of test is as indicated by the manufacturer.		N/A
	If no indications are given, the test period is 30 days		N/A
	After the test, when the transformers have returned to room temperature, they fulfil the following requirements:		N/A
	a) The output voltage has not changed from the measured value at the beginning by more than allowed value of clause 11.1		N/A
	b) The insulation resistance between input and output winding and between windings and body is, measured with 500 V d.c. , not less than 1 MOhm		N/A
	c) The transformer fulfil the dielectric strength test with 35% of the values in Clause 18, Table 8.a.		N/A
	The test result is positive, is min. 6 of the 7 samples have passed the test.		N/A
	The test result is negative, if 2 or more samples fail the test		N/A
	If the result is negative, the test can be repeated with 7 new samples		N/A
U.3	Short circuit and overload protection (addition to clause 15)		N/A
	At short circuit and overload tests the winding temperature if less than the required value of table U.1		N/A
U.5	General requirements and information about thermal endurance test on windings		N/A
U.5.1	Thermal endurance test		N/A
	Transformers tested at rated output		N/A
	Loads outside of the oven		N/A
	7 transformers are placed in the oven		N/A
	The temperature of the hottest winding of each of the 7 transformers is-together with the oven temperature, at the applicable temperature of table U.2		N/A

IEC 61558-2-16			
Clause	Requirement + Test	Result - Remark	Verdict
	After 4 hours measuring of the actual winding temperatures. Regulation of the oven temperature if necessary		N/A
	After 24 hours again measuring of the winding temperature. The temperatures of the 7 samples are very near to the required temperature of the values of table U.2. The test time of the coldest winding is not longer than twice the theoretical test time based on table U.2		N/A
U.5.2	The use of constant S other than 4500 in tw tests		N/A
U.5.2.1	Procedure a)		N/A
	The manufacturer prepares test results with a minimum of samples of 30.		N/A
	T and log L are calculated from the dates		N/A
	The diagram according to Figure U.2 will be founded.		N/A
U.5.2.3	Procedure b)		N/A
	The testing authority shall test 14 new transformers		N/A
	Test 1, based on clause U.5.1 but at the calculated test room temperature for 10 days. The test is continued until all transformer fail.		N/A
	Calculation of the mean life L ₂ at temperature T ₂ according to U ₄		N/A
	Test 2, based on clause U.5.1 but at a calculated room temperature T ₂ (for 120 days). The test time with T ₂ exceeds L ₂ .		N/A
	If all transformers fail before L ₂ , the result is negative.		N/A

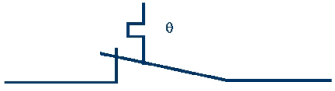
IEC 61558-2-16			
Clause	Requirement + Test	Result - Remark	Verdict
V	ANNEX V, SYMBOLS TO BE USED FOR THERMAL CUT-OUTS		N/A
V.2.1.1	Restored by manual operation  IEC 489/98		N/A
V.2.1.2	Restored by disconnection of the supply  IEC 490/98		N/A
V.2.1.3	Thermal link  IEC 491/98		N/A
V.2.2	Self-resetting thermal cut-out  IEC 492/98		N/A

IEC 61558-2-16			
Clause	Requirement + Test	Result - Remark	Verdict

11 and 12		TABLE: OUTPUT VOLTAGE AND OUTPUT CURRENT UNDER LOAD; NO-LOAD OUTPUT VOLTAGE					P
Clause		11		12		further information	
type/rated output/	rated voltage (V)	sec. voltage (V)	delta Usec (%)	Usec V no-load output	delta Usec no-load output %		
54.6V/3A	54.6	54.60	0	54.19	0.75%	100V/47Hz	
54.6V/3A	54.6	54.60	0	54.19	0.75%	100V/63Hz	
54.6V/3A	54.6	54.60	0	54.19	0.75%	240V/47Hz	
54.6V/3A	54.6	54.60	0	54.19	0.75%	240V/63Hz	
Limits:	--	--	±10	--	±15	--	

14	TABLE: heating			P
	Supply voltage (V)	90V/63Hz	264V/47Hz	--
	Maximum measured temperature T of part/at::	T (°C)		Required T(°C)
	Inlet	57.5	42.5	70
	CY1	71.4	50.3	125
	CY5	74.8	53.5	125
	CX1	98.7	60.4	100
	CX2	81.8	53.9	100
	VRP1	64.0	48.9	85
	CX0	70.4	50.8	120
	L1	92.8	59.4	120
	LF1	92.8	55.5	120
	LF2	113.1	66.3	120
	T1 winding	98.5	66.0	120
	T1 bobbin	100.7	68.1	120
	C23	90.9	71.9	105
	T3 winding	98.1	82.7	120
	T3 bobbin	99.5	81.6	120
	T2 Primary winding	97.2	87.7	110
	T2 secondary winding	98.8	89.3	110
	T2 bobbin	98.7	86.0	110
	CY8	60.6	64.3	125
	CY7	97.4	86.1	125
	U4	74.9	75.0	100
	U5	78.5	77.4	100

IEC 61558-2-16			
Clause	Requirement + Test	Result - Remark	Verdict
Ls5	69.5	72.5	120
PCB under BD1	118.4	72.8	130
PCB under Q15	116.5	74.4	130
PCB under T2	97.7	82.0	130
PCB under Ds2	99.5	67.5	130
Output wire (Internal)	57.9	67.9	70
Enclosure inside near T1	66.0	52.9	--
Enclosure outside near T1	63.4	51.8	80
Enclosure inside near L1	72.9	49.6	--
Enclosure inside near L1	66.6	46.6	80
Support	75.4	54.2	85
Input wire	30.1	28.8	--
Ambient	25.0	24.4	--
Max Ambient	25.0	24.4	--
Supplementary information: The heating test performed at unit continuous operation.			

15	TABLE: short-circuit and overload protection			P
	ambient temperature (°C)	25		--
	at 1,1 or 0,9 times rated voltage (V)	See below		--
Measured temperature of part/at:		T(°C)		Allowed T _{max} (°C)
Output overload test:				
Test voltage		90 V ac, 63Hz	264 V ac, 47Hz	--
1.	T2 primary winding	105.7	91.7	175
2.	T2 secondary winding	105.1	93.3	175
3.	Output wire	61.8	71.1	85
4.	Enclosure outside near BD1	67.6	53.1	105
5.	Enclosure outside above L1	78.5	48.0	105
6.	Enclosure outside under T2	71.8	51.0	105
7.	Support	31.4	29.0	105
8.	Ambient temperature during test	24.6	24.6	--
Maximum Ambient temperature		25	25	--
Output short-circuit test:				
Test voltage		90 V ac, 63Hz	264 V ac, 47Hz	--
1.	T2 primary winding	37.4		175
2.	T2 secondary winding	38.0		175

IEC 61558-2-16			
Clause	Requirement + Test	Result - Remark	Verdict
3.	Output wire	30.9	85
4.	Enclosure outside near BD1	28.2	105
5.	Enclosure outside above L1	28.5	105
6.	Enclosure outside under T2	31.2	105
7.	Support	32.2	105
8.	Ambient temperature during test	23.0	--
Maximum Ambient temperature		25	--

18.2	TABLE: insulation resistance measurements		P
Insulation resistance R between:		R (MΩ)	Required R (MΩ)
Between mains poles (primary fuse disconnected)		100	2
Between primary and enclosure		100	7
Between input and output		100	5
Between primary and secondary of T1		100	5
Between core and secondary of T1		100	5
Supplementary information:			

IEC 61558-2-16			
Clause	Requirement + Test	Result - Remark	Verdict

20	TABLE: Critical components information					P
Object/part No.	Manufacturer/ trademark	Type/model	Technical data	Standard (Edition / year)	Mark(s) of conformity ¹⁾	
Appliance Inlet	Rong Feng Industrial Co., Ltd.	RF-180	2.5A, 250Vac, 70°C	IEC/EN 60320-1	VDE (40030168)	
Fuse (F1)	Dong guan Better Electronic Technology Co., Ltd.	932	T5A, 250Vac	IEC/EN60127-1 IEC/EN60127-3	VDE (40033369)	
Alternative	Sunny East Enterprise Co. Ltd.	TSP	T5A, 250Vac	IEC/EN60127-1 IEC/EN60127-3	VDE (40027173)	
Varistor (VRP1)	Shantou High-New Technology Dev. Zone Songtian Enterprise Co., Ltd.	10D471K	Min.300Vac, 385Vdc,85°C	IEC/EN 61051-1 IEC/EN 61051-2 IEC/EN 61051-2-2	VDE (40023049)	
X-Capacitor (CX1)	Tenta Electric Industrial Co., Ltd.	MEX	0.33uF, 275Vac, 40/100/21	IEC/EN 60384-14	VDE (119119)	
Alternative	Farad Electronics Co., Ltd.	PXK	0.33uF, 275Vac, 40/110/56	IEC/EN 60384-14	VDE (40030152)	
Alternative	Shenzhen Weidy Industrial Development Co.,Ltd	MKP	0.33uF, 310Vac 40/110/56	IEC/EN 60384-14	VDE (40041066)	
X-Capacitor (CX2)	Tenta Electric Industrial Co., Ltd.	MEX	0.47uF, 275Vac, 40/100/21	IEC/EN 60384-14	VDE (119119)	
Alternative	Farad Electronics Co., Ltd.	PXK	0.47uF, 275Vac, 40/110/56	IEC/EN 60384-14	VDE (40030152)	
Alternative	Shenzhen Weidy Industrial Development Co.,Ltd	MKP	0.47uF, 310Vac 40/110/56	IEC/EN 60384-14	VDE (40041066)	
Y-Capacitor (CY1,CY2)	Success Electronics Co., Ltd.	SE	2200pF, 250Vac, 40/125/56, Y1	IEC/EN 60384-14	VDE (40020002)	

IEC 61558-2-16					
Clause	Requirement + Test			Result - Remark	Verdict
Alternative	Kunshan Micro Capacitors Electronic Co., Ltd.	E-Series	2200pF, 250Vac, 25/125/21, Y1 type	IEC/EN 60384-14	VDE (40016537)
Alternative	Yinan Don's Electronic Components Co., Ltd.	CT81	2200pF, 250Vac, 25/125/21, Y1 type	IEC/EN 60384-14	VDE (135256)
Alternative	Hsuan Tai Electronic Co., Ltd.	CY	2200pF, 400Vac, 40/125/21, Y1 type	IEC/EN 60384-14	VDE (40008912)
Alternative	Anshan Kei Fat Electronic Ceramic Technical Co., Ltd.	CT7	2200pF, 250Vac, 25/125/21, Y1 type	IEC/EN 60384-14	VDE (40011817)
Y-Capacitor (CY4,CY5)	Success Electronics Co., Ltd.	SE	1000pF, 250Vac, 40/125/56, Y1 type	IEC/EN 60384-14	VDE (40020002)
Alternative	Kunshan Micro Capacitors Electronic Co., Ltd.	E-Series	1000pF, 250Vac, 25/125/21, Y1 type	IEC/EN 60384-14	VDE (40016537)
Alternative	Yinan Don's Electronic Components Co., Ltd.	CT81	1000pF, 250Vac, 25/125/21, Y1 type	IEC/EN 60384-14	VDE (135256)
Alternative	Hsuan Tai Electronic Co., Ltd.	CY	1000pF, 400Vac, 40/125/21, Y1 type	IEC/EN 60384-14	VDE (40008912)
Alternative	Anshan Kei Fat Electronic Ceramic Technical Co., Ltd.	CT7	1000pF, 250Vac, 25/125/21, Y1 type	IEC/EN 60384-14	VDE (40011817)
Y-Capacitor (CY6,CY7 , CY8)	Success Electronics Co., Ltd.	SE	4700pF, 250Vac, 40/125/56, Y1 type	IEC/EN 60384-14	VDE (40020002)
Alternative	Kunshan Micro Capacitors Electronic Co., Ltd.	E-Series	4700pF, 250Vac, 25/125/21, Y1 type	IEC/EN 60384-14	VDE (40016537)
Alternative	Yinan Don's Electronic Components Co., Ltd.	CT81	4700pF, 250Vac, 25/125/21, Y1 type	IEC/EN 60384-14	VDE (135256)

IEC 61558-2-16					
Clause	Requirement + Test			Result - Remark	Verdict
Alternative	Hsuan Tai Electronic Co., Ltd.	CY	4700pF, 400Vac, 40/125/21, Y1 type	IEC/EN 60384-14	VDE (40008912)
Alternative	Anshan Kei Fat Electronic Ceramic Technical Co., Ltd.	CT7	4700pF, 250Vac, 25/125/21, Y1 type	IEC/EN 60384-14	VDE (40011817)
Photo coupler (U3,U4,U5)	China Resources Semiconductor (ShenZhen) Ltd.	PC817C	Int. Cr : > 7.62 mm, Ext. Cr : > 7.62 mm, Dti : > 0.4 mm, T110	IEC/EN 60747-5-5	VDE (40042139)
Alternative	Lite-On Technology Corporation	LTV-817	Int. Cr : > 7 mm, Ext. Cr : > 7 mm, Dti : > 0.4 mm, T115	IEC/EN 60747-5-5	VDE (40015248)
Line choke (CX0)	BORUN Electronics Factory	T10*4*5-01	130°C	IEC/EN 61558-1 IEC/EN 61558-2-16	Tested with appliance
Line choke (L1)	HUAIAN YAOLING ELECTRONIC CO.,LTD	L-22*10*6.5-240uH	130°C	IEC/EN 61558-1 IEC/EN 61558-2-16	Tested with appliance
Line choke (Ls5)	HUAIAN YAOLING ELECTRONIC CO.,LTD	L-18*10*6-10uH	130°C	IEC/EN 61558-1 IEC/EN 61558-2-16	Tested with appliance
Line choke (LF1,LF2)	HUAIAN YAOLING ELECTRONIC CO.,LTD	L-18*10*7-10mH	130°C	IEC/EN 61558-1 IEC/EN 61558-2-16	Tested with appliance
Line choke (T1)	HUAIAN YAOLING ELECTRONIC CO.,LTD	SSL300V67-PFC	130°C	IEC/EN 61558-1 IEC/EN 61558-2-16	Tested with appliance
Line choke (T3)	HUAIAN YAOLING ELECTRONIC CO.,LTD	SSL-67LS	130°C	IEC/EN 61558-1 IEC/EN 61558-2-16	Tested with appliance

IEC 61558-2-16					
Clause	Requirement + Test			Result - Remark	Verdict
Transformer (T2)	HUAIAN YAOLING ELECTRONIC CO.,LTD	SSB300V54.6-3T	Class B N1(3-2): Φ:0.1*30*16Ts; N3(2-1): Φ:0.1*30*16Ts; N4(5-4): Φ:0.3*4Ts. ; N2(9-10): Φ:0.1*80*9Ts; N2 (11-12) : Φ:0.1*80*9Ts; N5(7-8): Φ:0.3*3Ts; N6(P1-P2): Φ:0.3*4Ts	IEC/EN 61558-1 IEC/EN 61558-2-16	Tested with appliance
-Bobbin	CHANG CHUN PLASTICS CO LTD	T375J	Phenolic, V-0, 150°C, min. Thickness: 0.5mm	IEC/EN 61558-1 IEC/EN 61558-2-16	UL (E59481) +Tested with appliance
-Magnet wire	WUXI JUFENG COMPOUND LINE CO LTD	xUEWN*	130°C	IEC/EN 61558-1 IEC/EN 61558-2-16	UL (E206882) +Tested with appliance
-Magnet wire	DONG GUAN YIDA INDUSTRIAL CO LTD	2UEW	130°C	IEC/EN 61558-1 IEC/EN 61558-2-16	UL (E344055) +Tested with appliance
-Triple insulated wire	Dah Jin Technology Co., Ltd.	TLW-B	130°C	IEC/EN 60950-1 IEC/EN 61558-1 IEC/EN 61558-2-16	VDE (40008834) +Tested with appliance
-Tube	FLUO TECH INDUSTRIES CO LTD	TFL	200°C,	IEC/EN 61558-1 IEC/EN 61558-2-16	UL (E175982) +Tested with appliance
-Barrier Tape	JINGJIANG YAHUA PRESSURE SENSITIVE GLUE CO LTD	WF	130°C	IEC/EN 61558-1 IEC/EN 61558-2-16	UL (E165111) +Tested with appliance
-Insulation tape	XINYU SHENGDAFENG ELECTRIC MATERIAL CO LTD	SDF-312	130°C	IEC/EN 61558-1 IEC/EN 61558-2-16	UL (E317896) +Tested with appliance

IEC 61558-2-16					
Clause	Requirement + Test			Result - Remark	Verdict
-Margin tape	JINGJIANG YAHUA PRESSURE SENSITIVE GLUE CO LTD	WF	130°C	IEC/EN 61558-1 IEC/EN 61558-2-16	UL (E165111) +Tested with appliance
PCB	CHANGZHOU SHUANGJIN ELECTRONIC CO LTD	CCEM-1	V-0, 130°C	IEC/EN 61558-1 IEC/EN 61558-2-16	UL (E190089) +Tested with appliance
Alternative	CHANGZHOU ZIYIN ELECTRONIC CIRCUIT CO LTD	CY-10	V-0, 130°C	IEC/EN 61558-1 IEC/EN 61558-2-16	UL (E148151) +Tested with appliance
Enclosure	SABIC INNOVATIVE PLASTICS JAPAN L L C	C2950	V-0, 75°C Min 2.5 thickness	IEC/EN 61558-1 IEC/EN 61558-2-16	UL (E207780) + Tested with appliance
Output cord	Shangyu Jintao Electron Co.,Ltd	H03VV-F	2X0.75mm ²	EN 50525-2-11	VDE (40013419)
Alternative	Shangyu Jintao Electron Co.,Ltd	H03VVH2-F	2X0.75mm ²	EN 50525-2-11	VDE (40013419)
Alternative	Shenzhen Dongju Wire&Cable Co.,Ltd	H03VV-F	2X0.75mm ²	EN 50525-2-11	VDE (129988)
Alternative	Shenzhen Bao Hing Electric Wire & Cable Manufacture Co. Ltd.	H03VV-F	2X0.75mm ²	EN 50525-2-11	VDE (131689)
Supplementary information:					
1) Provided evidence ensures the agreed level of compliance. See OD-CB2039					

IEC 61558-2-16				
Clause	Requirement + Test		Result - Remark	Verdict
26	Table: working voltage measurement			P
Location		RMS voltage (V)	Peak voltage (V)	Comments
Transformer: T2				
From (Pri.)	To (Sec.)	RMS voltage (V) ("DC" coupling)	Peak voltage (V) ("AC + DC")	Comments
T2 Pin 1	Pin 7	1.63	3.33	At max. Rated load.
T2 Pin 2	Pin 7	142	332	At max. Rated load.
T2 Pin 3	Pin 7	220	258	At max. Rated load.
T2 Pin 4	Pin 7	1.11	1.3	At max. Rated load.
T2 Pin 5	Pin 7	0.941	1.15	At max. Rated load.
T2 Pin 1	Pin 8	0.782	1.84	At max. Rated load.
T2 Pin 2	Pin 8	128	308	At max. Rated load.
T2 Pin 3	Pin 8	197	408	At max. Rated load.
T2 Pin 4	Pin 8	122	226	At max. Rated load.
T2 Pin 5	Pin 8	119	202	At max. Rated load.
T2 Pin 1	Pin 9	126	338	At max. Rated load.
T2 Pin 2	Pin 9	163	172	At max. Rated load.
T2 Pin 3	Pin 9	262	336	At max. Rated load.
T2 Pin 4	Pin 9	122	221	At max. Rated load.
T2 Pin 5	Pin 9	1.67	1.74	At max. Rated load.
T2 Pin 1	Pin 10	138	172	At max. Rated load.
T2 Pin 2	Pin 10	111	266	At max. Rated load.
T2 Pin 3	Pin 10	152	358	At max. Rated load.
T2 Pin 4	Pin 10	146	242	At max. Rated load.
T2 Pin 5	Pin 10	133	256	At max. Rated load.
T2 Pin 1	Pin 11	111	260	At max. Rated load.
T2 Pin 2	Pin 11	126	318	At max. Rated load.
T2 Pin 3	Pin 11	198	398	At max. Rated load.
T2 Pin 4	Pin 11	123	230	At max. Rated load.
T2 Pin 5	Pin 11	119	206	At max. Rated load.
T2 Pin 1	Pin 12	118	282	At max. Rated load.
T2 Pin 2	Pin 12	135	368	At max. Rated load.
T2 Pin 3	Pin 12	202	415	At max. Rated load.
T2 Pin 4	Pin 12	112	222	At max. Rated load.
T2 Pin 5	Pin 12	119	192	At max. Rated load.
T2 Pin 1	Pin P1	74	204	At max. Rated load.
T2 Pin 2	Pin P1	101	266	At max. Rated load.

IEC 61558-2-16				
Clause	Requirement + Test	Result - Remark		Verdict
T2 Pin 3	Pin P1	184	362	At max. Rated load.
T2 Pin 4	Pin P1	171	272	At max. Rated load.
T2 Pin 5	Pin P1	169	252	At max. Rated load.
T2 Pin 1	Pin P2	70	192	At max. Rated load.
T2 Pin 2	Pin P2	120	282	At max. Rated load.
T2 Pin 3	Pin P2	205	388	At max. Rated load.
T2 Pin 4	Pin P2	169	248	At max. Rated load.
T2 Pin 5	Pin P2	170	266	At max. Rated load.
CY8 Primary	Secondary	12.1	22.4	At max. Rated load.
CY6 Primary	CY7 Secondary	119	210	At max. Rated load.
U4 Pin 1	Pin3	80.5	176	At max. Rated load.
U4 Pin 1	Pin3	80.5	176	At max. Rated load.
U4 Pin 2	Pin4	80.5	176	At max. Rated load.
U4 Pin 2	Pin4	80.5	176	At max. Rated load.
Remark: attach the measured oscilloscope chart				

26	TABLE: clearance and creepage distance measurements					P
Clearance (cl) and creepage distance (cr) at/of/between:	U r.m.s. (V)	Required cl (mm)	cl (mm)	Required dcr (mm)	dcr (mm)	
L and N before F1 (BI) on PCB trace	≤250	2.5	2.8	2.6	2.8	
Two ends of F1 (BI) on PCB trace	≤250	2.5	2.8	2.6	2.8	
Primary components to user accessible parts (enclosure outside) (RI)	≤250	4.7	6.8	5.0	6.8	
Primary components to secondary components (RI) Top side	262	4.9	See below	5.3	See below	
CY8 primary to secondary	262	4.9	8.4	5.3	8.4	
U4 Primary pin to C111	262	4.9	7.6	5.3	7.6	
U4/U3 Primary to secondary	262	4.9	7.8	5.3	7.8	
U3 Primary pin to Secondary PCB board to	262	4.9	7.3	5.3	>7.3	
SRQ1 trace to secondary heat-sink	262	4.9	7.6	5.3	7.6	
T2 primary trace to secondary trace	262	4.9	8.5	5.3	8.5	
T2 floating core to secondary trace (BI)	262	2.7	6.8	2.7	6.8	

IEC 61558-2-16					
Clause	Requirement + Test		Result - Remark		Verdict
Primary traces to secondary traces (RI)	≤250	4.9	See below	5.3	See below
Bottom side					
CY8 primary to secondary trace	262	4.9	8.2	5.3	8.2
U4/U3 primary to secondary	262	4.9	7.6	5.3	7.6
T2 primary to secondary	262	4.9	9.2	5.3	9.2
Heat-sink primary to secondary	262	4.9	9.6	5.3	9.6
CY6 Primary primary to secondary pin	262	2.7	6.2	2.7	6.2
CY7 Primary primary to secondary pin	262	2.7	7.5	2.7	7.5
C28B trace to CY6/CY7 floating pin	262	2.7	9.6	2.7	9.6
Note(s): <ol style="list-style-type: none"> 1. BI: Basic Insulation, SI: Supplementary Insulation, RI: Reinforced Insulation. 2. Core of transformer T1 considered as primary part. 3. 3 layers of insulation tape wrapped around core of transformer. 4. 3 layers of insulation tape wrapped around Secondary PCB board (near U3 side). 5. Insulation sheet added between transformer T2 and Secondary PCB board. 6. Internal wires soldered to PCB are additionally glued. 7. The required values are found for intermediate values of working voltages by interpolation. <ul style="list-style-type: none"> - Working voltage is 250V, BI or SI: cl. = 2.5mm, cr. = 2.6mm; RI: cl. = 4.7mm, cr. = 5.0mm - Working voltage is 262V, BI or SI: cl. = 2.7mm, cr. = 2.7mm; RI: cl. = 4.9mm, cr. = 5.3mm 					

26	Safety isolation transformer	P
Construction details:		
Transformer part name: T2		
Manufacturer: See component list table		
Type: See component list table		
Effective voltage rms	262V	
Required clearance for reinforced insulation (from table 13 by interpolation)	4.9mm	
Required creepage distance for reinforced insulation (from table 13 by interpolation)	5.3mm	
Measured min. creepage distance		
Location	inside (mm)	outside (mm)
Primary to secondary	6.0	14.1
Primary to core	3.0	7.0

IEC 61558-2-16			
Clause	Requirement + Test	Result - Remark	Verdict

Secondary to core		3.0	7.1
Measured min. clearances			
Location		inside (mm)	outside (mm)
Primary to secondary		6.0	14.1
Primary to core		3.0	7.0
Secondary to core		3.0	7.1

Construction:

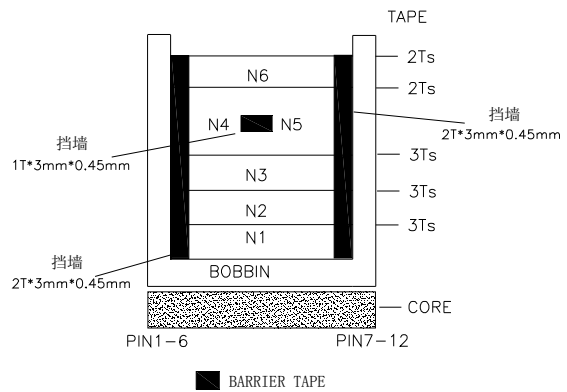
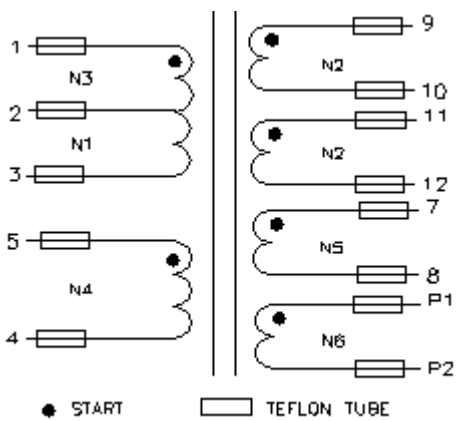
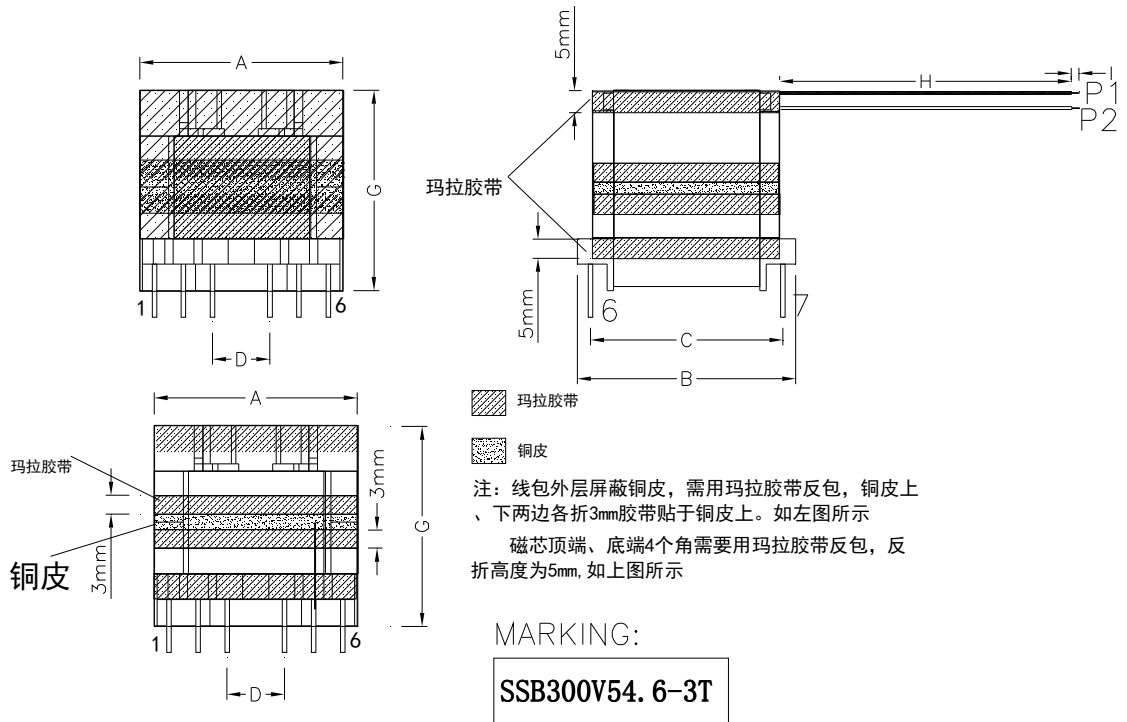

IEC 61558-2-16			
Clause	Requirement + Test	Result - Remark	Verdict

绕组 WINDING	漆包线 WIRE (mm)	起末端 S-F	圈数 TURNS (Ts)	胶带圈数 TAPE TURNS (Ts)	绕制方式 WINDING CONDITION
N1	∅ 0.10x30	3-2	16	3	密绕
N2	∅ 0.10x80	9-10	9	3	双线并绕
	∅ 0.10x80	11-12	9		
N3	∅ 0.10x30	2-1	16	2	密绕
N4	TEX∅ 0.3	5-4	4	2	密绕
N5	TEX∅ 0.3	7-8	3	2	密绕
N6	TEX∅ 0.3	P1-P2	4	2	密绕

Electric strength test	
With 4200V*) after humidity treatment (interpolation at T2's highest working voltage 262V)	
Result	Pass

26.2 TEST A	TABLE: CREEPAGE DISTANCES AND CLEARANCES AND DISTANCES THROUGH INSULATION					N/A
	Test with three special prepared specimens with uninsulated wires, without potting or impregnation					
	cycles with 2 x working voltage between pri / sec	68 h at the temperature acc. Cl. 14 (min. 85 °C)	1 hour 25 °C	2 hour 0 °C	1 hour 25 °C	
1.						
2.						
3.						
4.						
5.						
6.						
7.						
8.						
9.						
10.						

BB.26.2 TEST B	TABLE: CREEPAGE DISTANCES AND CLEARANCES AND DISTANCES THROUGH INSULATION					N/A
	Test with three specially prepared specimens with potted – P1 values are required					

IEC 61558-2-16						
Clause	Requirement + Test	Result - Remark			Verdict	
	cycles with 2 x working voltage between pri / sec	68 h at the temperature acc. Cl. 14 (min. 85 °C)	1 hour 25 °C	2 hour 0 °C	1 hour 25 °C	
1.						
2.						
3.						
4.						
5.						
6.						
7.						
8.						
9.						
10.						

IEC 61558-2-16						
Clause	Requirement + Test				Result - Remark	Verdict
26.2 TEST C	TABLE: CREEPAGE DISTANCES AND CLEARANCES AND DISTANCES THROUGH INSULATION					N/A
	Test with three specially prepared specimens with potting (only dti is required)					
	cycles with 2 x working voltage between pri / sec	68 h at the temperature acc. Cl. 14 (min. 85 °C)	1 hour 25 °C	2 hour 0 °C	1 hour 25 °C	
1.						
2.						
3.						
4.						
5.						
6.						
7.						
8.						
9.						
10.						

26.107 61558-2- 16/A1	TABLE: CREEPAGE DISTANCES AND CLEARANCES AND DISTANCES THROUGH INSULATION					N/A
	Test for transformers, use FIW-wire					
	cycles with 2 x working voltage between pri / sec	68 h at the temperature acc. Cl. 14 (min. 85 °C)	1 hour 25 °C	2 hour 0 °C	1 hour 25 °C	
1.						
2.						
3.						
4.						
5.						
6.						
7.						
8.						
9.						
10.						

IEC 61558-2-16						
Clause	Requirement + Test				Result - Remark	Verdict
H.2.3	TABLE: Fault conditions tested as specified when relevant:					P
	Ambient temperature (C)				25 C if no other specified	
	Applied input voltage (V)				See below	
Component No.	Fault	Supply voltage (V)	Test time	Fuse #	Fuse current (A)	Observation
Output	o-l	264	4h45min	F1	0.782	Overloaded up to 3.3A fold-back. No damage, no hazards.
Output	s-c	264	30min	F1	0.048	Unit shutdown. No damage, no hazards.
Output	o-l	90	4h22min	F1	2.197	Overloaded up to 3.3A fold-back. No damage, no hazards.
Output	s-c	90	3h38	F1	0.056	Unit shutdown. No damage, no hazards.
Transformer pin 7-8	s-c	264	10min	F1	0.087	Fuse opened immediately, no damage, no hazards.
Transformer pin 9-10	s-c	264	10min	F1	0.087	Unit shutdown. No damage, no hazards.
LF1	s-c	264	1s	F1	0	Fuse opened immediately, no damage, no hazards.
BD1	s-c	264	1s	F1	0	Fuse opened immediately, no damage, no hazards.
C23	s-c	264	1s	F1	0	Fuse opened immediately, no damage, no hazards.
Q1 D - G	s-c	264	10min	F1	0.688	Output normal. No damage, no hazards.
Q1 D - S	s-c	264	10min	F1	0.688	Output normal. No damage, no hazards.
U4 pin 1 - 2	s-c	264	10min	F1	0.692	Output normal. No damage, no hazards.
U4 pin 3 - 4	s-c	264	10min	F1	0.692	Output normal. No damage, no hazards.
U4 pin 3	o-c	264	10min	F1	0.692	Output normal. No damage, no hazards.
U3 pin 1 - 2	s-c	264	10min	F1	0.080	Unit shutdown. No damage, no hazards.
U3 pin 3 - 4	s-c	264	10min	F1	0.086	Unit shutdown. No damage, no hazards.
U3 pin 3	o-c	264	10min	F1	0.086	Unit shutdown. No damage, no hazards.
Ds2	s-c	264	10min	F1	0.086	Input 1.35W. No damage, no hazards.





IEC 61558-2-16						
Clause	Requirement + Test				Result - Remark	Verdict
Cs14	s-c	264	10min	F1	0.060	Unit shutdown. No damage, no hazards.
U1 pin3-8	s-c	264	10min	F1	0.087	Unit shutdown. No damage, no hazards.
U1 pin1-8	s-c	264	10min	F1	0.089	Unit shutdown. No damage, no hazards.
U1 pin11-8	s-c	264	10min	F1	0.694	Output normal. No damage, no hazards.
U2 pin14-4	s-c	264	10min	F1	0.090	Unit shutdown. No damage, no hazards.
U2 pin15-4	s-c	264	10min	F1	0.086	Unit shutdown. No damage, no hazards.
U2 pin7-4	s-c	264	10min	F1	0.086	Unit shutdown. No damage, no hazards.
<p>Supplementary information: The unit passed 4200V hi-pot test between primary and accessible output connector after single fault test above.</p> <p>1. In fault column, s-c=short-circuited, o-c=open-circuited, o-l=over-loaded.</p>						











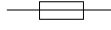

IEC 61558-2-16														
Clause	Requirement + Test										Result - Remark		Verdict	
Annex U	U.5.1 THERMAL ENDURANCE TEST													
Type ref.														
Rated PRI-Voltage														
Rated SEC-Voltage														
Material of Winding														
Material of bobbin														
Material of resin														
Material of potting														
Material of foil														
Components removed for test														
tw														
S														
Objective test duration (days)														
Theoretical test temperature														
Sample	1		2		3		4		5		6		7	
Winding	PRI	SEC	PRI	SEC	PRI	SEC	PRI	SEC	PRI	SEC	PRI	SEC	PRI	SEC
Start – Rk														
After 4 h – Rw														
After 4 h – winding temperature														
After 4 h - oven temperature														
After 24 h – Rw														
After 24 h – winding temperature														
After 24 h - oven temperature														
Final test period (days)														
Output voltage (11.1) under load														
Insulating resistance														
High voltage test														

IEC 61558-2-16														
Clause	Requirement + Test										Result - Remark			Verdict
(35% of the values in Table 8.a)														
Annex U	U.5.2 The use of another constant S other than 4500 in tw tests Test1:10 days													
Type ref.														
Rated PRI-Voltage														
Rated SEC-Voltage														
Material of Winding														
Material of bobbin														
Material of resin														
Material of potting														
Material of foil														
Components removed for test														
tw														
S														
Objective test duration (days)														
Theoretical test temperature														
Sample	1		2		3		4		5		6		7	
Winding	PRI	SEC	PRI	SEC	PRI	SEC	PRI	SEC	PRI	SEC	PRI	SEC	PRI	SEC
Start – Rk														
After 4 h – Rw														
After 4 h – winding temperature														
After 4 h - oven temperature														
After 24 h – Rw														
After 24 h – winding temperature														
After 24 h - oven temperature														
Final test period (days)														
Output voltage (11.1) under load														

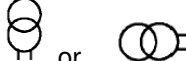
IEC 61558-2-16														
Clause	Requirement + Test										Result - Remark		Verdict	
Insulating resistance														
High voltage test (35% of the values in Table 8.a)														
IEC 61558-2-16														
Annex U	U.5.2 The use of another constant S other than 4500 in tw tests Test2:120 days													
Type ref.														
Rated PRI-Voltage														
Rated SEC-Voltage														
Material of Winding														
Material of bobbin														
Material of resin														
Material of potting														
Material of foil														
Components removed for test														
tw														
S														
Objective test duration (days)														
Theoretical test temperature														
Sample	1		2		3		4		5		6		7	
Winding	PRI	SEC	PRI	SEC	PRI	SEC	PRI	SEC	PRI	SEC	PRI	SEC	PRI	SEC
Start – Rk														
After 4 h – Rw														
After 4 h – winding temperature														
After 4 h - oven temperature														
After 24 h – Rw														
After 24 h – winding temperature														
After 24 h - oven temperature														

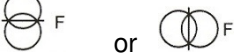
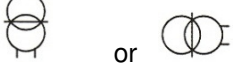
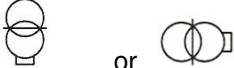
IEC 61558-2-16							
Clause	Requirement + Test					Result - Remark	Verdict
Final test period (days)							
Output voltage (11.1) under load							
Insulating resistance							
High voltage test (35% of the values in Table 8.a)							

AA	Annex AA		N/A
	Partial discharge (PD) test		N/A
			N/A
BB	Annex BB		N/A
	Particular requirements for associated transformers for switch mode power supplies with internal frequencies > 500 Hz		
	See separate test report-form for these Annex.		N/A
BB.8	MARKING AND OTHER INFORMATION		N/A
BB.8.2	Marking for transformers IP00 or for associated transformers: type and trademark, instruction sheets		N/A
BB.8.11	Correct symbols:		N/A
	Volts	V	N/A
	Amperes	A (mA)	N/A
	Volt amperes (or volt-amperes reactive for reactors)	VA or (VAR)	N/A
	Watts	W	N/A
	Hertz	Hz	N/A
	Input	PRI	N/A
	Output	SEC	N/A
	Direct current	d.c. (DC) or 	N/A
	Neutral	N	N/A
	Single-phase a.c.		N/A
	Three-phase a.c.	3 	N/A
	Three-phase and neutral a.c.	3N 	N/A
	Power factor	cos	N/A
	Class II construction		N/A

IEC 61558-2-16			
Clause	Requirement + Test	Result - Remark	Verdict
	Class III construction		N/A
	Fuse-link		N/A
	Rated max. ambient temperature	t_a	N/A
	Frame or core terminal		N/A
	Protective earth		N/A
	IP number	IPXX	N/A
	Earth (ground for functional earth)		N/A
	For indoor use only		N/A
	tw5 YYY		N/A
	tw10 YYY		N/A
	twx YYY		N/A
	Additional Symbols (IEC 61558-2-16:09)		N/A
	SMPS incorporating a Fail-safe separating transformer		N/A
	Additional Symbols (IEC 61558-2-16:09)		N/A
	SMPS incorporating a Non-short-circuit-proof separating transformer		N/A
	SMPS incorporating a Short-circuit-proof separating transformer (inherently or non-inherently)		N/A
	SMPS incorporating a Fail-safe isolating transformer		N/A
	SMPS incorporating a Non-short-circuit-proof isolating transformer		N/A
	SMPS incorporating a Short-circuit-proof isolating transformer (inherently or non-inherently)		N/A
	SMPS incorporating a Fail-safe safety isolating transformer		N/A
	SMPS incorporating a Non-short-circuit-proof safety isolating transformer		N/A
	SMPS incorporating a Short-circuit-proof safety isolating transformer (inherently or non-inherently)		N/A
	SMPS (Switch mode power supply unit)		N/A

IEC 61558-2-16			
Clause	Requirement + Test	Result - Remark	Verdict
BB.9	PROTECTION AGAINST ELECTRIC SHOCK		N/A
BB.10	CHANGE OF INPUT VOLTAGE SETTING		N/A
BB.11	OUTPUT VOLTAGE AND OUTPUT CURRENT UNDER LOAD		N/A
BB.12	NO-LOAD OUTPUT VOLTAGE (see supplementary requirements in Part 2)		N/A
BB.13	SHORT-CIRCUIT VOLTAGE		N/A
BB.14	HEATING		N/A
BB.14.2	Application of 14.1 or 14.3 according to the insulation system		N/A
BB.14.2.1	Class of isolating system (classified materials according to IEC 60 085 and IEC 60 216)		N/A
BB.14.2.2	No classified material, or system but the measured temperature does not exceed the value of Class A		N/A
BB.14.2.3	No classified material or system but the measured temperature exceeds the value for Class A, the live parts of the transformers are submitted to the test of 14.3		N/A
BB.14.3	Accelerated ageing test for undeclared class of isolating system		N/A
	Cycling test (10 cycles):		N/A
	– measuring of the no-load input current (mA)		N/A
BB.14.3.1	– heat run (temperature in table 2)		N/A
BB.14.3.2	– vibration test: 30 min; amplitude 0,35 mm; frequency range: 10 Hz, 55 Hz, 10 Hz		N/A
BB.14.3.3	– moisture treatment (48 h, 17.2)		N/A
BB.14.3.4	Measurements and tests at the beginning and after each test:		N/A
	– deviation of the no-load input current, measured at the beginning of the test is 30%		N/A
	– insulation resistance acc. cl.18.1 and 18.2		N/A

IEC 61558-2-16			
Clause	Requirement + Test	Result - Remark	Verdict
	– electric strength, no breakdown (18.3); 2 min; test voltage 35% of specified value (table VI)		N/A
	– Transformers (50 or 60 Hz version) are tested after the dielectric strength test as follows: under no load; duration: 5 min; Upri(V):1,2 times rated supply voltage; frequency (Hz): 2 times rated frequency		N/A
BB.15	SHORT-CIRCUIT AND OVERLOAD PROTECTION		N/A
BB.16	MECHANICAL STRENGTH		N/A
BB.17	PROTECTION AGAINST HARMFUL INGRESS OF WATER AND MOISTURE		N/A
BB.18	INSULATION RESISTANCE AND ELECTRIC STRENGTH		N/A
BB.18.2	Insulation resistance between:		N/A
	– live parts and body for basic insulation 2 M		N/A
	– live parts and body for reinforced insulation 7 M		N/A
	– input circuits and output circuits for basic insulation 2 M		N/A
	– input circuits and output circuits for double or reinforced insulation 5 M		N/A
	– each input circuit and all other input circuits connected together 2 M		N/A
	– each output circuit and all other output circuits connected together 2 M		N/A
	– hazardous live parts and metal parts with basic insulation (Class II transformers) 2 M		N/A
	– body and metal parts with basic insulation (Class II transformers) 5 M		N/A
	– metal foil in contact with inner and outer sur- faces of enclosures 2 M		N/A
BB.18.3	Electric strength test (1 min): no flashover or breakdown:		N/A

IEC 61558-2-16			
Clause	Requirement + Test	Result - Remark	Verdict
	1) basic insulation between input circuits and output circuits; working voltage (V); test voltage (V)		N/A
	2) double or reinforced insulation between input circuits and output circuits; working voltage (V); test voltage (V)		N/A
	3) basic or supplementary insulation between:		N/A
	a) live parts of different polarity; working voltage (V); test voltage (V)		N/A
	b) live parts and the body if intended to be connected to protective earth		N/A
	c) inlet bushings and cord guards and anchorages		N/A
	d) live parts and an intermediate conductive part		N/A
	e) intermediate conductive parts and body :		N/A
	4) Reinforced insulation between the body and live parts; working voltage (V); test voltage (V)		N/A
	5) Functional insulation for windings intended to be connected in series or parallel (test voltage = working voltage + 500 V) (IEC 61558-2-16:2009)		N/A
18.102 (A1)	Partial discharge tests according IEC 60664-1 , if the working voltage is > 750 V peak		N/A
	Partial discharge is ≤ 10 pC at time P2 See Fig. 19.101		N/A

BB.19	CONSTRUCTION		N/A
BB.19.1	Separation of input and output circuits		N/A
BB.19.1.1	SMPS incorporating auto-transformers (IEC 61558-2-16:2009)		N/A
BB.19.1.2	SMPS incorporating separating transformers (IEC 61558-2-16:2009)		N/A
BB.19.1.2.1	Input and output circuits electrically separated. (IEC 61558-2-16:09)		N/A
BB.19.1.2.2	The insulation between input and output winding(s) consist of basic insulation (IEC 61558-2-16:09)		N/A
	Class I SMPS		N/A

IEC 61558-2-16			
Clause	Requirement + Test	Result - Remark	Verdict
	– Insulation between input windings and body consist of basic insulation		N/A
	– Insulation between output windings and body consist of basic insulation		N/A
	Class II SMPS (IEC 61558-2-16:09)		N/A
	– Insulation between input windings and body consist of double or reinforced insulation		N/A
	– Insulation between output windings and body consist of double or reinforced insulation		N/A
BB.19.1.2.3	The insulation between input windings and intermediate conductive parts and the output windings and intermediate part consist of basic insulation (IEC 61558-2-16:09)		N/A
	For class I SMPS the insulation between input and output windings via the intermediate conductive parts consist of basic insulation (IEC 61558-2-16:09)		N/A
	For class II SMPS the insulation between input winding and the body and between the output windings and the body via the intermediate conductive parts consist of double or reinforced insulation (IEC 61558-2-16:09)		N/A
BB.19.1.2.4	Parts of output circuits may be connected to protective earth (IEC 61558-2-16:09)		N/A
BB.19.1.2.5	No direct contact between output circuits and the body, unless: (IEC 61558-2-16:2009)		N/A
	– Allowed for associated transformers by the equipment standard		N/A
	– Clause 19.8 of part 1 is fulfilled		N/A
BB.19.1.3	SMPS incorporating isolating transformers and safety isolating transformers (IEC 61558-2-16:09)		N/A
BB.19.1.3.1	Input and output circuits electrically separated (IEC 61558-2-16:09)		N/A
	No possibility of any connection between these circuits		N/A
BB.19.1.3.2	The insulation between input and output winding(s) consist of double or reinforced insulation (exception see 19.1.3.4) (IEC 61558-2-16:09)		N/A
	Class I SMPS not intended for connection to the mains by a plug:		—

IEC 61558-2-16			
Clause	Requirement + Test	Result - Remark	Verdict
	– Insulation between input windings and body connected to earth consist of basic insulation rated to the input voltage		N/A
	– Insulation between output windings and body, connected to earth consist of basic insulation rated for the output voltage		N/A
	Class I SMPS intended for connection to the mains by a plug (EN 61558-2-16:09):		N/A
	– Insulation between input windings and body connected to earth consist of basic insulation rated to the working voltage		N/A
	– Insulation between output windings and body, connected to earth consist of supplementary insulation rated for the working voltage		N/A
			N/A
	Class II SMPS (IEC 61558-2-16:09)		N/A
	– Insulation between input windings and body consist of double or reinforced insulation rated to the input voltage		N/A
	– Insulation between output windings and body consist of double or reinforced insulation, rated to the output voltage		N/A
BB.19.1.3.3	SMPS with intermediate conductive parts not connected to the body (between input/output) (EN 61558-2-16:09):		N/A
19.1.3.3.1	For class I and class II SMPS the insulation between input and output windings, via intermediate conductive parts, consist of double or reinforced insulation, rated to the working voltage (EN 61558-2-16:09)		N/A
	– For class II SMPS the insulation between input winding and the body and between the output windings and the body via the intermediate conductive parts consist of double or reinforced insulation. (rated to the input voltage, for SELV circuits only basic insulation to the body))		N/A
	– For transformers, different from independent, the insulation between input and output windings, via intermediate conductive parts, consist of double or reinforced insulation, rated to the working voltage.		N/A

IEC 61558-2-16			
Clause	Requirement + Test	Result - Remark	Verdict
BB.19.1.3.3.2	Class I transformers with earthed core, and not allowed for class II equipment (EN 61558-2-16:09)		N/A
	– Insulation from the input to the earthed core: basic insulation rated for the input voltage		N/A
	– Insulation from the output voltage to the earthed core: basic insulation rated for the output voltage		N/A
BB.19.1.3.3.3	Insulation between : input to intermediate conductive parts and output and intermediate parts consist of at least basic insulation (EN 61558-2-16:09)		N/A
	– If the insulation from input or output to the intermediate metal part is less than basic insulation, the part is considered to be connected to input or output.		N/A
BB.19.1.3.4	For class I SMPS, with protective screen, not connected to the mains by a plug the following conditions comply (EN 61558-2-16:09):		N/A
	– The insulation between input winding and protective screen consist of basic insulation (rated input voltage)		N/A
	– The insulation between output winding and protective screen consist of basic insulation (rated output voltage)		N/A
	– The protective screen consist of metal foil or a wire wound screen extending the full width of the windings and has no gaps or holes		N/A
	– Where the protective screen does not cover the entire width of the input winding, additional insulation to ensure double insulation in this area, is used.		N/A
	– If the screen is made by a foil, the turns are isolated, overlap at least 3 mm		N/A
	– The cross-section of the screen and the lead out wire is at least corresponding to the rated current of the overload device		N/A
	– The lead our wire is soldered or fixed to the protective screen.		N/A
	Protective screening is not allowed for SMPS with plug connection to the mains (EN 61558-2-16:09)		N/A

IEC 61558-2-16			
Clause	Requirement + Test	Result - Remark	Verdict
BB.19.1.3.5	No connection between output circuit and protective earth, except of associated transformers (allowed by equipment standard) or 19.8 is fulfilled (EN 61558-2-16:09)		N/A
BB.19.1.3.6	No connection between output circuit and body, except of associated transformers (allowed by equipment standard) (EN 61558-2-16:09)		N/A
BB.19.1.3.7	The distance between input and output terminals for the connection of external wiring is 25 mm		N/A
BB.19.1.3.8	Portable SMPS having an rated output \leq 630 VA (EN 61558-2-16:09)		N/A
BB.19.1.3.9	No connection between output circuit, and body except of associated transformers (allowed by equipment standard) (EN 61558-2-16:09)		N/A
BB.19.1.3.10	Protective screening is not allowed for SMPS with plug connection to the mains (EN 61558-2-16:09)		N/A
BB.19.11	Handles, levers, knobs, etc.:		N/A
	– insulating material		N/A
	– supplementary insulation covering		N/A
	– separated from shafts or fixing by supplementary insulation		N/A
BB.19.12	Windings construction		N/A
BB.19.12.1	Undue displacement in all types of transformers not allowed:		N/A
	– of input or output windings or turns thereof		N/A
	– of internal wiring or wires for external connection		N/A
	– of parts of windings or of internal wiring in case of rupture or loosening		N/A
BB.19.12.2	Serrated tape:		N/A
	– distance through insulation according to table 13		N/A
	– one additional layer of serrated tape, and		N/A
	– one additional layer without serration		N/A
	– in case of cheek less bobbins the end turns of each layer shall be prevented from being displaced		N/A

IEC 61558-2-16			
Clause	Requirement + Test	Result - Remark	Verdict
BB.19.12.3 (A1)	Insulated windings wires providing basic, supplementary or reinforced insulation, meet the following requirements:		N/A
	– Multi-layer extruded or spirally wrapped insulation, passed the tests of annex K		N/A
	– Basic insulation: two wrapped or one extruded wire		N/A
	– Supplementary insulation: two layers, wrapped or extruded		N/A
	– Reinforced insulation: three layers wrapped or extruded		N/A
	Spirally wrapped insulation:		N/A
	– creepage distances between wrapped layers > cl. 26 _ P1 values		N/A
	– path between wrapped layers sealed, the test voltage of K2 is multiplied with 1,35		N/A
	– test 26.2.3 – Test A, passed for wrapped layers		N/A
	– the finished component pass the electric strength test according to cl. 18.3		N/A
a)	Insulated winding wire used for basic or supplementary insulation in a wound part:		N/A
	– comply with annex K		N/A
	– two layers for supplementary insulation		N/A
	– one layer for basic insulation		N/A
	– one layer for mechanical separation between the insulated wires of primary and secondary. This layer fulfils the requirement of basic insulation.		N/A
b)	Insulated winding wire used for reinforced insulation in a wound part:		N/A
	– comply with annex K		N/A
	– three layers		N/A
	– relevant dielectric strength test of 18.3		N/A
	Where the insulated winding wire is wound:		N/A
	– upon metal or ferrite cores		N/A
	– upon enamelled wire		N/A

IEC 61558-2-16			
Clause	Requirement + Test	Result - Remark	Verdict
	– under enamelled wire		N/A
	– one layer for mechanical separation between the insulated wires and the core or the enamelled wires is required. This layer fulfils the requirement of basic insulation.		N/A
	– both windings shall not touch each other and also not the core.		N/A
	100 % routine test of Annex K3 of part 1 is fulfilled		N/A
	no creepage distances and clearances for insulated winding wirers		N/A
	for TIW wires values of box 2) c) of table 13, table C.1 and table D.1 of part 1 and of clause 26.106 are not required		N/A
FIW	<u>Transformers which use FIW wire</u>		N/A
BB 19.12.101 (A1)	Max. class F for transformers which use FIW-wire		N/A
BB 19.12.102 (A1)	FIW wires comply with IEC 60851-5, Ed.4.1; IEC 60317-0-7 and IEC 60317-56, Ed.1.		N/A
	– other nominal diameter as mentioned in table 19.101 can be calculated with the formula after table 19.111		N/A
	FIW wire used for basic or supplementary insulation for transformers according 19.1.2 (separating-transformers) of IEC 61558-2-16:		N/A
	– the test voltage of table 8a – part 1, based on the working voltage of basic or supplementary insulation, comply with the min. voltage strength of table 19.111		N/A
	– one layer for mechanical separation is located between the insulated wires of primary and secondary. This layer fulfil the requirement of basic insulation		N/A
	– between FIW and enamelled wire, no requirements of creepage distances and clearances		N/A
	– no touch of FIW and enamelled wires (grad 1, or grad 2 ...)		N/A
	FIW wire used for double or reinforced insulation for transformers according 19.1.3 (isolating and safety isolating transformers) of IEC 61558-2-16 (PRI and SEC basic insulated FIW-wire):		N/A

IEC 61558-2-16			
Clause	Requirement + Test	Result - Remark	Verdict
	– the test voltage of table 8a – part 1, based on the working voltage of basic or supplementary insulation, comply with the min. voltage strength of table 19.111		N/A
	– for primary and secondary winding FIW-wire for basic insulation is used		N/A
	– one layer for mechanical separation is located between the insulated wires of primary and secondary. This layer fulfil the requirement of basic insulation		N/A
	– no touch between the basic insulated PRI and SEC FIW-wires		N/A
	– between PRI- and SEC-FIW wires, no requirements of creepage distances and clearances		N/A
	Alternative construction used for reinforced insulation (reinforced insulated FIW wire and enamelled wire)		N/A
	– the test voltage of table 8a – part 1, based on the working voltage reinforced insulation, comply with the min. voltage strength of table 19.111		N/A
	– one layer for mechanical separation is located between the reinforced insulated FIW wire and the enamelled wire. This layer fulfil the requirement of basic insulation		N/A
	– no touch between the FIW wire and the enamelled wire		N/A
	– between the reinforced FIW wire and any other parts, no requirements of creepage distances and clearances exist		N/A
	Alternative construction with FIW wires, basic or supplementary insulated for transformers with double or reinforced insulation according to 19.1.3 (basic/supplementary insulated FIW wire + enamelled wire + creepage distance and clearances for basic insulation)		N/A
	– the test voltage of table 8a – part 1, based on the working voltage of basic or supplementary insulation, comply with the min. voltage strength of table 19.111		N/A
	– PRI or SEC basic insulated FIW wire and to the other winding (enamelled wire) requirements of supplementary insulation		N/A

IEC 61558-2-16			
Clause	Requirement + Test	Result - Remark	Verdict
	– creepage distances and clearances between the basic insulated FIW wire and the enamelled wire for basic or supplementary insulation are required.		N/A
	Where the FIW wire is wound		N/A
	– upon metal or ferrite cores		N/A
	– one layer for mechanical separation between the insulated wires and the core or the enamelled wires is required. This layer fulfils the requirement of basic insulation.		N/A
	– both windings shall not touch each other and also not the core.		N/A
BB.20	COMPONENTS		N/A
BB.21	INTERNAL WIRING		N/A
BB.22	SUPPLY CONNECTION AND EXTERNAL FLEXIBLE CABLES AND CORDS		N/A
BB.23	TERMINALS FOR EXTERNAL CONDUCTORS		N/A
BB.24	PROVISION FOR PROTECTIVE EARTHING		N/A
BB.25	SCREWS AND CONNECTIONS		N/A
BB.26	CREEPAGE DISTANCES AND CLEARANCES		N/A
BB.26.1	See 26.101		N/A
BB.26.2	Creepage distances (cr) and clearances (cr)		N/A
BB.26.2.1	Windings covered with adhesive tape		N/A
	– the values of pollution degree 1 are fulfilled		N/A
	– all isolating material are classified acc. to IEC 60085 and IEC 60216		N/A
	– test A of 26.2.3 is fulfilled		N/A
BB.26.2.2	Uncemented insulating parts pollution degree P2 or P3		N/A
	– all isolating material are classified acc. to IEC 60085 and IEC 60216		N/A

IEC 61558-2-16			
Clause	Requirement + Test	Result - Remark	Verdict
	– values of pollution degree 1 are not applicable		N/A
BB.26.2.3	Cemented insulating parts		N/A
	– all isolating materials are classified acc. to IEC 60085 and IEC 60216		N/A
	– values of distance through insulation (dti) are fulfilled		N/A
	– creepage distances and clearances are not required		N/A
	– test A of this sub clause is fulfilled		N/A
	Test A		N/A
	– thermal class		N/A
	– working voltage		N/A
	– Test with three specially specimens, with uninsulated wires, without impregnation or potting		N/A
	Two of the three specimens are subjected to:		N/A
	– the relevant humidity treatment according to 17.2 (48 h)		N/A
	– the relevant dielectric strength test of 18.3 multiplied with factor 1,35		N/A
	– One of the three specimens is subjected to the relevant dielectric strength test of 18.3 multiplied by the factor 1,35 immediately at the end of the last cycle with high temperature		N/A
	Impulse dielectric test according to 4.1.1.2.1 of IEC 60 664-1 (1,2 / 50 s waveform) – see Annex R of IEC 61558-1		N/A
BB.26.2.4	Enclosed parts, by impregnation or potting		N/A
BB.26.2.4.1	– The requirements of reduced values as stated for pollution degree 1 (P1) are fulfilled		N/A
	– all isolating materials are classified acc. to IEC 60085 and IEC 60216		N/A
	Test B		N/A
	– thermal class		N/A
	– working voltage		N/A

IEC 61558-2-16			
Clause	Requirement + Test	Result - Remark	Verdict
	– Test with three specially specimens, potted or impregnated. The dielectric strength test is applied directly to the joint.		N/A
	Two of the three specimens are subjected to:		N/A
	– the relevant humidity treatment according to 17.2 (48 h)		N/A
	– the relevant dielectric strength test of 18.3 multiplied with factor 1,25		N/A
	– One of the three specimens is subjected to the relevant dielectric strength test of 18.3 multiplied by the factor 1,25 immediately at the end of the last cycle with high temperature		N/A
	The three spacemen pass the Impulse dielectric test according to 4.1.1.2.1 of IEC 60 664-1 (1,2 / 50 s waveform) – see Annex R of IEC 61558-1		N/A
BB.26.2.4.2	– The requirements of distance through insulation (dti) are fulfilled. (P1 values are not required)		N/A
	– all isolating materials are classified acc. to IEC 60085 and IEC 60216		N/A
	Test C		N/A
	– thermal class		N/A
	– working voltage		N/A
	– Test with three specimens, potted or impregnated. (finished components)	(see appended table)	N/A
	– Neither cracks, nor voids in the insulating compounds		N/A
	Two of the three specimens are subjected to:		N/A
	– the relevant humidity treatment according to 17.2 (48 h)		N/A
	– the relevant dielectric strength test of 18.3 multiplied with factor 1,35		N/A
	– One of the three specimens is subjected to the relevant dielectric strength test of 18.3 multiplied by the factor 1,35 immediately at the end of the last cycle with high temperature		N/A

IEC 61558-2-16			
Clause	Requirement + Test	Result - Remark	Verdict
	The three spacemen pass the Impulse dielectric test according to 4.1.1.2.1 of IEC 60 664-1 (1,2 / 50 s waveform) – see Annex R of IEC 61558-1		N/A
BB.26.3	Distance through insulation		N/A
	For double or reinforced insulation, the required values of Tables 13, C1, and D1 – boxes 2b, 2c and 7 are fulfilled		N/A
	The insulation fulfil the material classification according IEC 60085 or 60216 or the test of 14.3		N/A
BB.26.3.1	Reduced values of the thickness of insulation for supplementary or reinforced insulation are allowed if the following conditions are fulfilled:		N/A
	– the isolating materials are classified acc. to IEC 60085 and IEC 60216		N/A
	– the test of 14.3 is fulfilled		N/A
	– If both requirements are fulfilled, the required values for solid insulation can be multiplied by 0,4		N/A
	– Minimum thickness of reinforced insulation $\geq 0,2$ mm		N/A
	– Minimum thickness of supplementary insulation $\geq 0,1$ mm		N/A
BB.26.3.2	Insulation in thin sheet form		N/A
	– If the layers are non-separable (glued together):		N/A
	– The requirement of 3 layers is fulfilled		N/A
	– The mandrel test according 26.3.3 is fulfilled with 150 N		N/A
	– The required values for d.t.i. of Tables 13, C.1 and D.1 – marked by index "e" is fulfilled.		N/A
	– If the layers are separated:		N/A
	– The requirement of 2 layers is fulfilled		N/A
	– If serrated tape is used, 1 additional layer (serrated) and one additional layer without serration is required		N/A
	– The mandrel test according 26.3.3 is fulfilled on each layer with 50 N		N/A

IEC 61558-2-16			
Clause	Requirement + Test	Result - Remark	Verdict
	– The required values for d.t.i. of Tables 13, C.1 and D.1 – marked by index "e" is fulfilled.		N/A
	– If the layers are separated (alternative:		N/A
	– The requirement of 3 layers is fulfilled		N/A
	– If serrated tape is used, 1 additional layer (serrated) and one additional layer without serration is required		N/A
	– The mandrel test according 26.3.3 is fulfilled on 2/3 of the layers with 100 N		N/A
	– The required values for d.t.i. of Tables 13, C.1 and D.1 – marked by index "e" is fulfilled.		N/A
	Test according to 14.3 and if the isolating materials are classified acc. to IEC 60085 and IEC 60216 no distances through insulation are required for insulation in thin sheet form		N/A
	The figures within square brackets in box 2 and 7 of table 13 (C.1/D.1) are used for insulation in thin sheet form as follows:		N/A
	– rated output > 100 VA values in square brackets apply		N/A
	– rated output 25 VA 100 VA 2/3 of the value in square brackets apply		N/A
	– rated output __ 25 VA 1/3 of the value in square brackets apply		N/A
BB.26.3.3	Mandrel test of insulation in thin sheet form (specimen of 70 mm width are necessary):		N/A
	– If the layers are non-separable – at least 3 layers glued together fulfil the test:		N/A
	– pull force of 150 N		N/A
	– high voltage test of 5,0 kV or the test voltage of 18.3 multiplied by 1,25 whatever is the greater. No flashover, no breakdown.		N/A
	– If the layers are separable and 2/3 of at least 3 layers fulfil the test.		N/A
	– pull force of 100 N		N/A

IEC 61558-2-16			
Clause	Requirement + Test	Result - Remark	Verdict
	– high voltage test of 5,0 kV or the test voltage of 18.3 multiplied by 1,25 whatever is the greater. No flashover, no breakdowns.		N/A
	– If the layers are separable 1 of at least 2 layers fulfil the test:		N/A
	– pull force of 50 N		N/A
	– high voltage test of 5,0 kV or the test voltage of 18.3 multiplied by 1,25 whatever is the greater. No flashover, no breakdown.		N/A
BB.26.101	Creepage distances, clearances and distances through insulation, specified values according to (EN 61558-2-16:09):		N/A
	– table 13, material group IIIa (part 1)		N/A
	– table C, material group II (part 1)		N/A
	– table D, material group I (part 1)		N/A
	– working voltage		N/A
	– rated supply frequency 50/60 Hz		N/A
	– rated internal frequency		N/A
	1. Insulation between input and output circuits (basic insulation):		N/A
	a) measured values specified values (mm)		N/A
	2. Insulation between input and output circuits (double or reinforced insulation):		N/A
	a) measured values specified values (mm)		N/A
	b) measured values specified values (mm)		N/A
	c) measured values specified values (mm)		N/A
	3. Insulation between adjacent input circuits: measured values specified values (mm)		N/A
	Insulation between adjacent output circuits: measured values specified values (mm)		N/A

IEC 61558-2-16			
Clause	Requirement + Test	Result - Remark	Verdict
	4. Insulation between terminals for external connection:		N/A
	a) measured values specified values (mm)		N/A
	b) measured values specified values (mm)		N/A
	c) measured values specified values (mm)		N/A
	5. Basic or supplementary insulation:		N/A
	a) measured values specified values (mm)		N/A
	b) measured values specified values (mm)		N/A
	c) measured values specified values (mm)		N/A
	d) measured values specified values (mm)		N/A
	e) measured values specified values (mm)		N/A
	6. Reinforced or double insulation: measured values specified values (mm)		N/A
	7. Distance through insulation:		N/A
	a) measured values specified values (mm)		N/A
	b) measured values specified values (mm)		N/A
	c) measured values specified values (mm)		N/A
BB.26.102	Values of IEC 61558-2-16 applicable for frequency up to 3 MHz (EN 61558-2-16:09)		N/A
	For frequency above 3 MHz clause 7 of IEC 60664-4 is applicable (high frequency testing)		N/A
BB.26.103	Clearance (EN 61558-2-16:09)		N/A
	a.) Clearance for frequency ≥ 30 kHz according figure 101 two determinations are necessary:		N/A
	– determination based on peak working voltage according Table 104 :		N/A
	Peak working voltage		N/A
	Basic insulation: required / measured		N/A

IEC 61558-2-16			
Clause	Requirement + Test	Result - Remark	Verdict
	Double or reinforced insulation: required / measured value		N/A
	– and alternative if applicable for approximately homogeneous field according to Table 102		N/A
	Peak working voltage		N/A
	Basic insulation: required / measured		N/A
	Double or reinforced insulation: required / measured value		N/A
	– determination based on measured r.m.s. working voltage according Tables 13, C1 and D1 (see clause 26.101)		N/A
	The minimum clearance is the greater of the two values.		N/A
	b.) Clearance for frequency ≤ 30 kHz according figure 101 two determinations are necessary:		N/A
	– determination based on peak working voltage with recurring peak voltages according Table 103 :		N/A
	– determination based on measured r.m.s. working voltage according Tables 13, C1 and D1 (see clause 26.101)		N/A
	The minimum clearance is the greater of the two values.		N/A
BB.26.104	The working voltages of Table 102, 103 and 104 are peak voltages including μ sec peaks EN 61558-2-16:09)		N/A
	The working voltage according to Table 13 of part 1 are r.m.s. voltages		N/A
BB.26.105	Creepage distances		N/A
	Two determinations of creepage distances are necessary (see Figure 102)		N/A
	– determination based on measured peak working voltage according Tables 105 to 110		N/A
	Peak working voltage		N/A
	Pollution degree		N/A
	Basic or supplementary insulation: required / measured		N/A
	Double or reinforced insulation: required / measured value		N/A

IEC 61558-2-16			
Clause	Requirement + Test	Result - Remark	Verdict
	– determination based on measured r.m.s. working voltage according Tables 13, C1 and D1 (see clause 26.101)		N/A
	If the values based on table 105 to 110 are lower than the relevant values in Tables 13, C.1 or D.1, the higher values shall be applicable		N/A
BB.26.106	Distance through insulation (EN 61558-2-16:09)		N/A
	Instead of partial discharge with high frequency voltage the test of the distance and the calculation of the electric field is applicable under the following conditions:		N/A
	– the max. frequency is < 10 MHz		N/A
	– the field strength approximately comply with Figure 103		N/A
	– no voids or gaps are present in between the solid insulation		N/A
	For thick layers $d1 \geq 0,75$ the peak value of the field strength is ≤ 2 kV/mm		N/A
	For thin layers $d2 \leq 30 \mu\text{m}$ the peak value of the field strength is ≤ 10 kV/mm		N/A
	For $d1 > d > d2$ equation (1) is used for calculation the field strength		N/A
BB.26.107 (A1)	For transformers with FIW wires the following test is required		N/A
	– 10 cycles are required		N/A
	– 68 h test at max heating temperature + 10°C or test at max. allowed winding temperature based on the insulation class (required in table 1) + 10°C		N/A
	– 1 h at 25° C		N/A
	– 2 h at 0° C		N/A
	– 1 h at 25° C – (next cycle start again with 68 h max winding temp + 10)		N/A
	– during the 10 cycles test 2 x working voltage is connected between PRI and SEC		N/A
	– after 10 cycle test 2 transformers are subjected to the 17.2 test for 48 h and direct after the 48 h the dielectric strength test of 18.3 (100 % test voltage) is done		N/A

IEC 61558-2-16			
Clause	Requirement + Test	Result - Remark	Verdict
	– after the 10 cycle test the third sample is tested at the end of the last cycle in the hot position with the dielectric strength test of 18.3 (100 % test voltage)		N/A
	– the partial discharge test according to 18.101 is done after the cycling test and after the high voltage test, if the peak working voltage is >750 V		N/A

BB.27	RESISTANCE TO HEAT, FIRE AND TRACKING		N/A
IEC 61558-2-16 Annex BB			
Clause	Requirement + Test	Result - Remark	Verdict

BB.E	ANNEX E , GLOW WIRE TEST		N/A
	The test is required according to IEC 60695-2-10 and IEC 60695-2-11 with the following additions:		N/A
BB.E.1	Clause 6, "Severities" of IEC 6095-2-11, apply with the temperature stated in 27.3 of IEC 61558-1		N/A
BB.E2	Clause 8, "Conditioning", of IEC 60695-2-11 apply, preconditioning is required		N/A
BB.E3	Clause 10, "Test Procedure", of IEC 60695-2-11 apply, The tip of the glow wire is applied to the flat side of the surface.		N/A

BB.F	ANNEX F, REQUIREMENTS FOR MANUALLY OPERATED SWITCHES WHICH ARE PARTS OF THE TRANSFORMER		N/A
-------------	--	--	-----

BB.H	ANNEX H, ELECTRONIC CIRCUITS (IEC 61558-1)		N/A
-------------	---	--	-----

BB.K 61558-2-16/A1	ANNEX K, INSULATED WINDING WIRES FOR USE AS MULTIPLE LAYER INSULATION		N/A
BB.K.1	Wire construction:		N/A
	– insulated winding wire for basic or supplementary insulation (see 19.12.3)		N/A
	– insulated winding wire for reinforced insulation (see 19.12.3)		N/A
	– solid circular winding wires and stranded winding wires with 0,05 to 5 mm diameter		N/A

IEC 61558-2-16			
Clause	Requirement + Test	Result - Remark	Verdict
	– spirally wrapped insulation - overlapping		N/A
BB.K.2	Type tests		N/A
BB.K.2.1	General Tests between ambient temperature between 15° C and 35° C and at an humidity between 45% and 75 %		N/A
BB K.2.2	Electric strength test		N/A
BB K.2.2.1	Solid circular winding wires and stranded winding wires		N/A
	Test samples prepared according to clause 4.4.1 of IEC 60851-5:2008 (twisted pair)		N/A
	Dielectric strength test: 6 kV for reinforced insulation		N/A
	Dielectric strength test: 3 kV for basic or supplementary insulation		N/A
BB K.2.2.2	Square or rectangular wires .		N/A
	Test samples prepared according to clause 4.7.1 of IEC 60851-5:2008		N/A
	Dielectric strength test: 5,5 kV for reinforced insulation		N/A
	Dielectric strength test: 2,75 kV for basic or supplementary insulation		N/A
BB K.2.3	Flexibility and adherence		N/A
	Claus 5.1 in Test 8 of IEC 60851-3:2009 shall be used		N/A
	Test samples prepared according to clause 5.1.1.4 of IEC 60851-3:2009		N/A
	Dielectric strength test: 5,5 kV for reinforced insulation		N/A
	Dielectric strength test: 2,75 kV for basic or supplementary insulation		N/A
	Mandrel diameter according table K.1		N/A
	The tension to the wire during winding on mandrel is 118 N/mm ² (118 MPa)		N/A
BB.K.2.4	Heat shock		N/A
	Test samples prepared according to 3.1.1 (in Test 9) of IEC 60851-6:1996		N/A
	– high voltage test immediately after this test		N/A
	– Dielectric strength test: 5,5 kV for reinforced insulation		N/A

IEC 61558-2-16			
Clause	Requirement + Test	Result - Remark	Verdict
	– Dielectric strength test: 2,75 kV for basic or supplementary insulation		N/A
BB.K.2.5	Retention of dielectric strength after bending (test as specified under test 13 of 4.6.1 c) of IEC 60 851-5)		N/A
	– high voltage test immediately after this test		N/A
	– Dielectric strength test: 5,5 kV for reinforced insulation		
	– Dielectric strength test: 2,75 kV for basic or supplementary insulation		
BB.K.3	Testing during manufacturing		N/A
BB.K.3.1	General Tests as subjected in K.3.2 and K.3.3		N/A
BB K.3.2	Routine test		N/A
	– Dielectric strength test: 4,2 kV for reinforced insulation		N/A
	– Dielectric strength test: 2,1 kV for basic or supplementary insulation		N/A
BB K.3.3	Sampling test		N/A
BB K.3.3.1	Solid circular winding wires and stranded winding wires		N/A
	Test with a twisted pair, prepared according clause 4.4.1 of IEC 60851-5:2008		N/A
	– Dielectric strength test: 6 kV for reinforced insulation		N/A
	– Dielectric strength test: 3 kV for basic or supplementary insulation		N/A
BB K.3.3.2	Square rectangular wire		N/A
	Samples prepared according to clause 4.7.1 of IEC 60851-5:2008		N/A
	– Dielectric strength test: 5,5 kV for reinforced insulation		N/A
	– Dielectric strength test: 3 kV for basic or supplementary insulation		N/A
BB.U	ANNEX U – INFORMATIVE – OPTIONAL TW – MARKING FOR TRANSFORMERS		N/A
V	ANNEX V, SYMBOLS TO BE USED FOR THERMAL CUT-OUTS		N/A

IEC 61558-2-16					
Clause	Requirement + Test	Result - Remark			Verdict
BB.26.2 TEST A	TABLE: CREEPAGE DISTANCES AND CLEARANCES AND DISTANCES THROUGH INSULATION				N/A
	Test with three special prepared specimens with uninsulated wires, without potting or impregnation				
	cycles with 2 x working voltage between pri / sec	68 h at the temperature acc. Cl. 14 (min. 85 °C)	1 hour 25 °C	2 hour 0 °C	1 hour 25 °C
1.					
2.					
3.					
4.					
5.					
6.					
7.					
8.					
9.					
10.					

IEC 61558-2-16					
Clause	Requirement + Test	Result - Remark			Verdict
BB.26.2 TEST B	TABLE: CREEPAGE DISTANCES AND CLEARANCES AND DISTANCES THROUGH INSULATION				N/A
	Test with three specially prepared specimens with potted – P1 values are required				
	cycles with 2 x working voltage between pri / sec	68 h at the temperature acc. Cl. 14 (min. 85 °C)	1 hour 25 °C	2 hour 0 °C	1 hour 25 °C
1.					
2.					
3.					
4.					
5.					
6.					
7.					
8.					
9.					
10.					

IEC 61558-2-16					
Clause	Requirement + Test			Result - Remark	Verdict
BB.26.2 TEST B	TABLE: CREEPAGE DISTANCES AND CLEARANCES AND DISTANCES THROUGH INSULATION				N/A
	Test with three specially prepared specimens with potted – P1 values are required				
	cycles with 2 x working voltage between pri / sec	68 h at the temperature acc. Cl. 14 (min. 85 °C)	1 hour 25 °C	2 hour 0 °C	1 hour 25 °C

BB.26.2 TEST C					
TABLE: CREEPAGE DISTANCES AND CLEARANCES AND DISTANCES THROUGH INSULATION					N/A
	Test with three specially prepared specimens with potting (only dti is required)				
	cycles with 2 x working voltage between pri / sec	68 h at the temperature acc. Cl. 14 (min. 85 °C)	1 hour 25 °C	2 hour 0 °C	1 hour 25 °C
1.					
2.					
3.					
4.					
5.					
6.					
7.					
8.					
9.					
10.					

BB.26.107 61558-2-16/A1					
TABLE: CREEPAGE DISTANCES AND CLEARANCES AND DISTANCES THROUGH INSULATION					N/A
	Test for transformers, use FIW-wire				
	cycles with 2 x working voltage between pri / sec	68 h at the temperature acc. Cl. 14 (min. 85 °C)	1 hour 25 °C	2 hour 0 °C	1 hour 25 °C

IEC 61558-2-16					
Clause	Requirement + Test			Result - Remark	Verdict
BB.26.107 61558-2-16/A1	TABLE: CREEPAGE DISTANCES AND CLEARANCES AND DISTANCES THROUGH INSULATION				N/A
Test for transformers, use FIW-wire					
	cycles with 2 x working voltage between pri / sec	68 h at the temperature acc. Cl. 14 (min. 85 °C)	1 hour 25 °C	2 hour 0 °C	1 hour 25 °C
1.					
2.					
3.					
4.					
5.					
6.					
7.					
8.					
9.					
10.					

BB 18.2	TABLE: Dielectric Strength		N/A
Test voltage applied between:	Test potential applied (V)	Breakdown / flashover (Yes/No)	
Supplementary information:			

BB 18.3	TABLE: insulation resistance measurements		N/A
Insulation resistance R between:	R (MΩ)	Required R (MΩ)	
Supplementary information:			

BB 26	TABLE: Clearance And Creepage Distance Measurements	N/A
--------------	--	-----

IEC 61558-2-16						
Clause	Requirement + Test	Result - Remark				Verdict
clearance cl and creepage distance dcr at/of:	Up (V)	U r.m.s. (V)	Required cl (mm)	cl (mm)	required dcr (mm)	dcr (mm)
Supplementary information:						

BB 26	TABLE: Distance Through Insulation Measurements				N/A
Distance through insulation di at/of:	U r.m.s. (V)	Test voltage (V)	Required di (mm)	di (mm)	
Supplementary information:					